

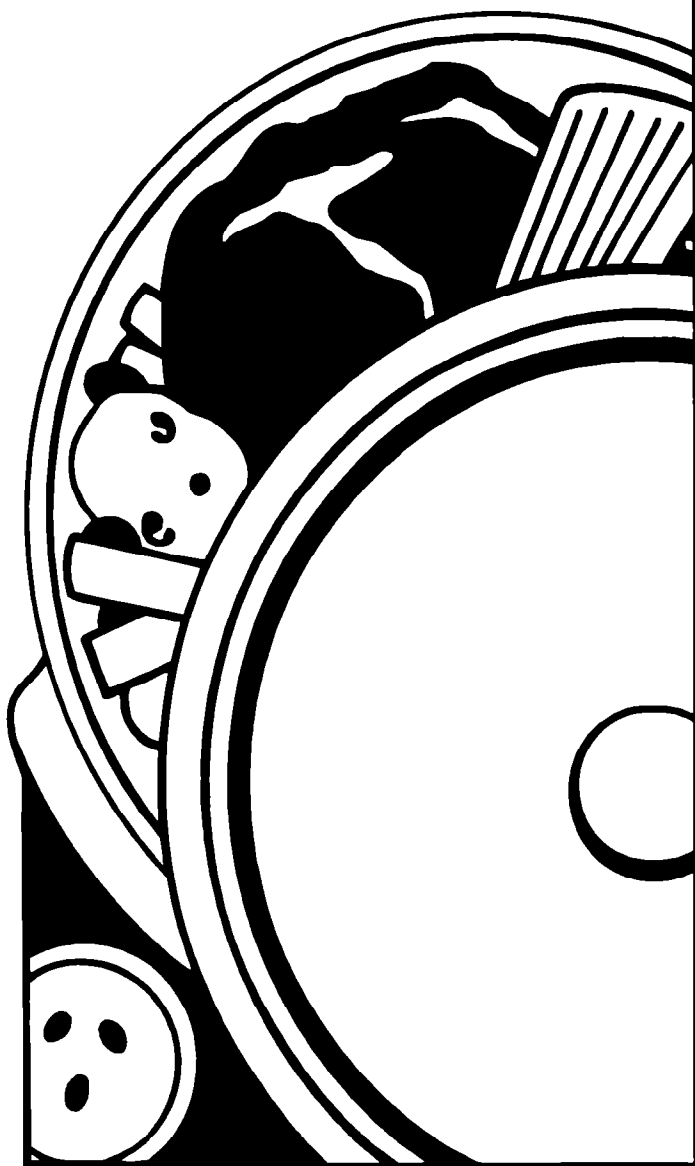

Use And Care

G U I D E



A Note To You	2
Understanding Micro- wave Oven Safety	3
Installation Instructions	8
Getting To Know Your Microwave- Convection Oven	10
Microwave Cooking	19
Convection Cooking	40
Combination Cooking	52
Caring For Your Microwave- Convection Oven	61
Cooking Guide	62
Questions And Answers	67
If You Need Assistance Or Service	68
Warranty	72

1-800-253-1301

Call us with questions or comments.

MICROWAVE-CONVECTION OVEN

MODEL MC8130XA

A NOTE TO YOU

A Note To You

Thank you for buying a Whirlpool® appliance.

You have purchased a quality, world-class home appliance. Years of engineering experience have gone into its manufacturing. To ensure that you will enjoy many years of trouble-free operation, we have developed this Use and Care Guide. It is full of valuable information on how to operate and maintain your appliance properly and safely. Please read it carefully. Also, please complete and mail the Ownership Registration Card provided with your appliance. This will help us notify you about any new information on your appliance.

Your safety is important to us.

This guide contains safety symbols and statements. Please pay special attention to these symbols and follow any instructions given. Here is a brief explanation of the use of each symbol.

⚠ WARNING

This symbol will help alert you to such dangers as personal injury, burns, fire and electrical shock.

⚠ CAUTION

This symbol will help you avoid actions which could cause product damage (scratches, dents, etc.) and damage to your personal property.

Our Consumer Assistance Center number, 1-800-253-1301, is toll-free, 24 hours a day.

If you ever have a question concerning your appliance's operation, or if you need service, first see "If You Need Assistance Or Service" on page 68. If you need further help, feel free to call our Consumer Assistance Center. When calling, you will need to know your appliance's complete model number and serial number. You can find this information on the model and serial number plate (see diagram on page 12). For your convenience, we have included a handy place below for you to record these numbers, the purchase date from the sales slip and your dealer's name and telephone number. Keep this book and the sales slip together in a safe place for future reference.

Model Number _____

Dealer Name _____

Serial Number _____

Dealer Phone _____

Purchase Date _____

Understanding Microwave Oven Safety

IMPORTANT SAFETY INSTRUCTIONS

Microwave ovens have been thoroughly tested for safe and efficient operation. However, as with any appliance, there are special installation and safety precautions which must be followed to ensure safe and satisfactory operation and prevent damage to the unit.

⚠ WARNING

To reduce the risk of burns, fire, electrical shock, injury to persons, exposure to excessive microwave energy, or damage when using the microwave oven, follow basic precautions, including the following:

- Read all instructions before using the microwave oven.
- Read and follow the specific "PRECAUTIONS TO AVOID POSSIBLE EXPOSURE TO EXCESSIVE MICROWAVE ENERGY" found on page 5.
- This appliance must be grounded. Connect only to properly grounded outlet. See "GROUNDING INSTRUCTIONS" found on page 9.
- Install or locate this appliance only in accordance with the provided Installation Instructions found on page 8.
- Some products such as whole eggs in the shell and sealed containers—for example, closed glass jars—may explode and should not be heated in this oven.
- Do not heat, store or use flammable materials in or near the oven. Fumes can create a fire hazard or explosion.
- Use this appliance only for its intended use as described in this manual. Do not use corrosive chemicals or vapors in this appliance. This type of oven is specifically designed to heat or cook food. It is not designed for industrial or laboratory use.
- As with any appliance, close supervision is necessary when used by children.
- Do not operate this appliance if it has a damaged cord or plug, if it is not working properly, or if it has been damaged or dropped. Electrical shock, fire or other hazards may result.
- This appliance should be serviced only by qualified service personnel. Call an authorized Whirlpool® service company for examination, repair or adjustment.
- Do not cover or block any opening on the appliance. Fire may result.
- Do not store or use this appliance outdoors. Do not use this product near water—for example, near a kitchen sink, in a wet basement, or near a swimming pool, and the like.
- Do not immerse cord or plug in water.
- Keep cord away from heated surfaces.
- Do not let cord hang over edge of table or counter.
- See door surface and interior cleaning instructions on page 61.
- To reduce the risk of fire in the oven cavity:
 - Do not overcook food. Carefully attend appliance if paper, plastic, or other combustible materials are placed inside the oven to facilitate cooking. Paper can char or burn, and some plastics can melt if used when heating foods.
 - Do not use paper, plastics, or other combustible materials when operating the microwave oven as a convection oven.
 - Do not deep fry in oven. Microwavable utensils are not suitable and it is difficult to maintain appropriate deep frying temperatures.

continued on next page

UNDERSTANDING MICROWAVE OVEN SAFETY

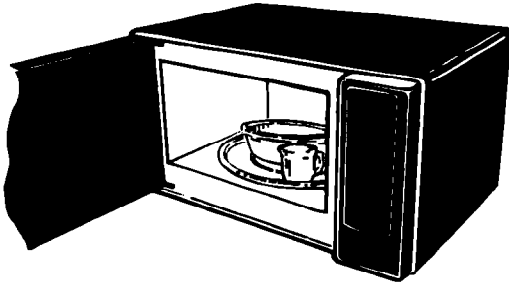

- **Test dinnerware or cookware before using.** To test a dish for safe use, put it into the oven with a cup of water beside it. Cook at 100% Cook Power for one minute. **If the dish gets hot and water stays cool, do not use it.** Some dishes (melamine, some ceramic dinnerware, etc.) absorb microwave energy, becoming too hot to handle and slowing cooking times. Cooking in metal containers not designed for microwave use can damage the oven, as can containers with hidden metal (twist-ties, foil lining, staples, metallic glaze or trim).
- Remove wire twist-ties from paper or plastic bags before placing bag in oven.

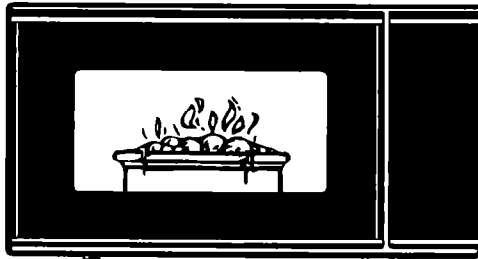

- If materials inside the oven should ignite, keep oven door closed, turn oven off, and disconnect the power cord or shut off power at the fuse or circuit breaker panel.

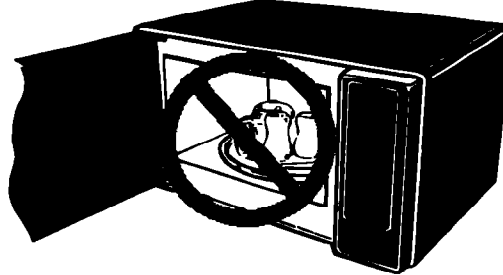

- Do not use the cavity for storage purposes. Do not leave paper products, cooking utensils, or food in the cavity when not in use.
- Do not mount over a sink.
- Do not store anything directly on top of the appliance when appliance is in operation.
- Read and follow "Operating safety precautions" starting on page 6.
- 1. A short power-supply cord is provided to reduce the risks resulting from becoming entangled in or tripping over a longer cord.
- 2. Longer cord sets or extension cords are available and may be used if care is exercised in their use.
- 3. If a long cord or extension cord is used temporarily, (a) the marked electrical rating of the cord set or extension cord should be at least as great as the electrical rating of the appliance, (b) the extension cord must be a grounding-type, 3-wire cord that has a 3-blade grounding plug and a 3-slot receptacle that will accept the plug on the appliance, and (c) the longer cord should be arranged so that it will not drape over the countertop or tabletop where it can be pulled on by children or tripped over accidentally.
- 4. A qualified electrician must install a properly grounded and polarized 3-prong receptacle near the appliance.

- SAVE THESE INSTRUCTIONS -

PRECAUTIONS TO AVOID POSSIBLE EXPOSURE TO EXCESSIVE MICROWAVE ENERGY...

Do not attempt to operate this oven with the door open since open-door operation can result in harmful exposure to microwave energy. It is important not to defeat or tamper with the safety interlocks.

Do not place any object between the oven front face and the door or allow soil or cleaner residue to accumulate on sealing surfaces.

Do not operate the oven if it is damaged. It is particularly important that the oven door close properly and that there is no damage to the:

- (1) Door (bent),
- (2) Hinges and latches (broken or loosened),
- (3) Door seals and sealing surfaces.

Do not operate the microwave oven if the door window is broken.

The microwave oven should be checked for microwave leakage by qualified service personnel after a repair is made.

The oven should not be adjusted or repaired by anyone except properly qualified service personnel.

Do not operate the microwave oven with the outer cabinet removed.

UNDERSTANDING MICROWAVE OVEN SAFETY

Operating safety precautions

⚠ WARNING

To reduce the risk of burns, fire, electrical shock, injury to persons, or damage when using the microwave oven, follow the precautions on pages 6-7.

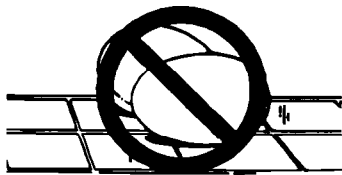

Never cook or reheat a whole egg inside the shell. Steam build-up in whole eggs may cause them to burst and burn you, and possibly damage the oven. **Slice** hard-boiled eggs before heating. In rare instances, poached eggs have been known to explode. **Cover** poached eggs and **allow** a standing time of one minute before cutting into them.



Stir before heating

For best results, stir any liquid several times before heating or reheating. Liquids heated in certain containers (especially cylindrical containers) may become overheated. The liquid may splash out with a loud noise during or after heating or when adding ingredients (coffee, etc.) resulting in harm to the oven and possible personal injury.



Never lean on the door or allow a child to swing on it when the door is open. Injury could result.

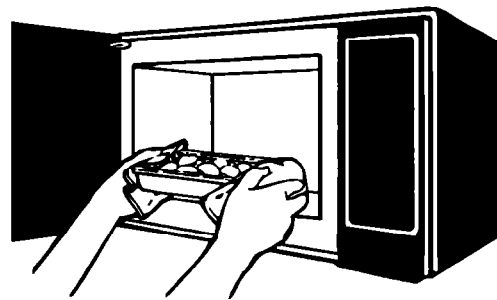

Use hot pads. Microwave energy does not heat containers, but the hot food does.

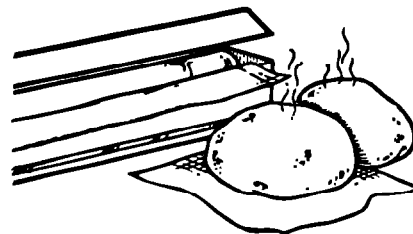

Do not overcook potatoes. Fire could result. At the end of the recommended cooking time, potatoes should be slightly firm because they will continue cooking during standing time. **After microwaving, wrap** potatoes in foil and **set aside** for 5 minutes. They will finish cooking while standing.

UNDERSTANDING MICROWAVE OVEN SAFETY

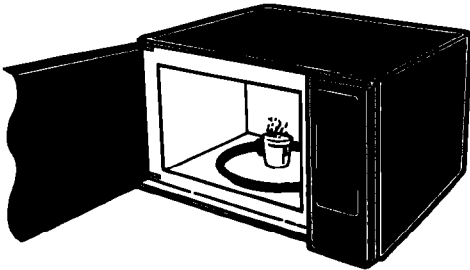

Do not start a microwave oven when it is empty. Product life may be shortened.
If you practice programming the oven, **put a container of water in the oven.**

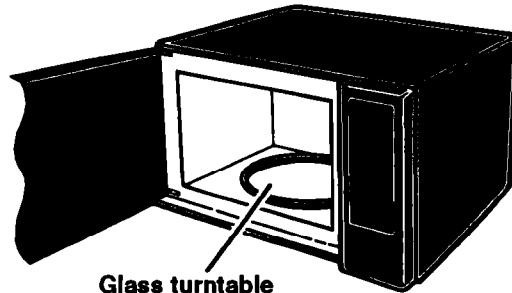

Do not operate in the microwave mode unless the ceramic glass turntable is securely in place and can rotate freely. The turntable can rotate in either direction.

Make sure the turntable is correct-side up in oven. Carefully place cookware on turntable to avoid possible breakage.

Handle turntable with care when removing from oven to avoid possible breakage. If turntable cracks or breaks, contact your Whirlpool dealer for a replacement.

When you use a browning dish, the browning dish bottom must be at least $\frac{3}{16}$ inch above the turntable. Follow directions supplied with browning dish.

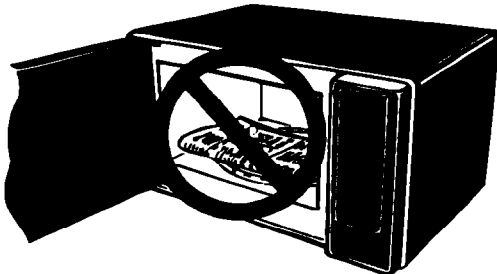

Do not use newspaper or other printed paper in the oven. Fire could result.

Do not dry flowers, fruit, herbs, wood, paper, gourds or clothes in the oven. Fire could result.

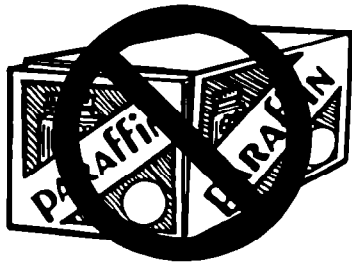

Do not try to melt paraffin wax in the oven. Paraffin wax will not melt in a microwave oven because it allows microwaves to pass through it.

General information

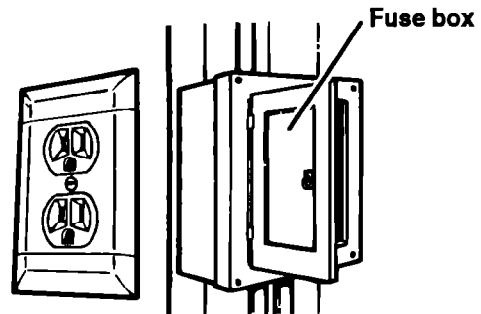

If your electric power line or outlet voltage is less than 110 volts, cooking times may be longer. Have a qualified electrician check your electrical system.

INSTALLATION INSTRUCTIONS

Installation Instructions

Before you begin operating the oven, carefully read the following instructions.

Installing your microwave oven

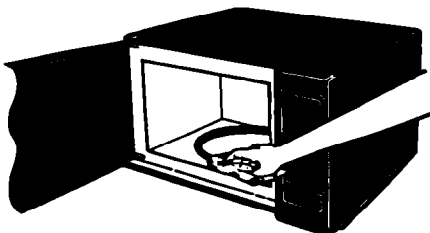

1. Empty the microwave oven and clean inside it with a soft, damp cloth. Check for damage such as misaligned door, damage around the door, or dents inside the oven or on the exterior. If there is any damage, do not operate the unit until it has been checked by an authorized Whirlpool® service technician and any repairs made.

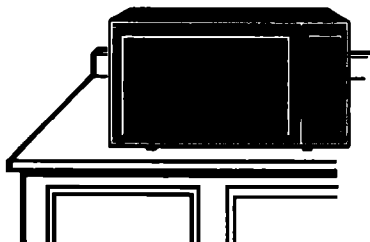

2. Put the oven on a cart, counter, table, or shelf that is strong enough to hold the oven and the food and utensils you put in it. (The control side of the unit is the heavy side. Use care when handling.) The weight of the oven is approximately 58 lbs (26.10 kg). The microwave oven should be at a temperature above 50°F (10°C) for proper operation.

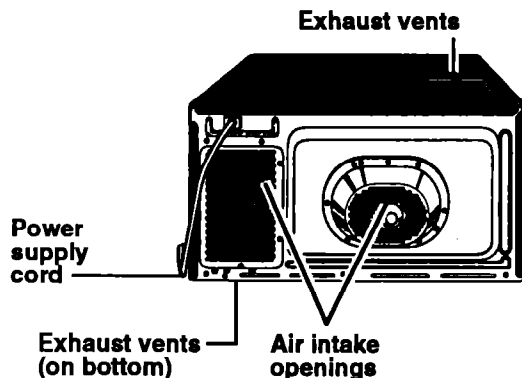

⚠ WARNING

Fire, Electrical Shock, Excessive Exposure To Microwave Energy, Personal Injury and Product Damage Hazard

- Do not block the exhaust vents or rear air intake openings. Allow a few inches of space at back of oven where intake openings are located. Blocking the air intake openings and exhaust vents can cause damage to the oven and poor cooking results. Make sure the microwave oven legs are in place to ensure proper airflow.
- Do not install the oven next to or over a heat source (for example, a cooktop or range) without a UL approved trim kit or without being in a UL approved built-in configuration. Also, do not install oven in any area where excessive heat and steam are generated. This could cause a fire, electrical shock, excessive exposure to microwave energy, other personal injury or damage to the outside of the cabinet.

Built-in kits

You can build your microwave-convection oven into a wall or cabinet by using one of the trim kits listed on page 15.

These kits are available from your Whirlpool Dealer. If your dealer does not stock the kit, it can be ordered, by kit part number, by writing to:

Whirlpool Corporation
Attention: Customer Service Dept.
1900 Whirlpool Drive
LaPorte, IN 46350

INSTALLATION INSTRUCTIONS

3. Electrical requirements

Observe all governing codes and ordinances. A 120 Volt, 60 Hz, AC only, 15 or 20 amp fused electrical supply is required.

(Time-delay fuse is recommended.) It is recommended that a separate circuit serving only this appliance be provided.

4. GROUNDING INSTRUCTIONS

⚠ WARNING

Electrical Shock Hazard

Improper use of the grounding plug can result in a risk of electrical shock. **DO NOT, UNDER ANY CIRCUMSTANCES, REMOVE THE POWER SUPPLY CORD GROUNDING PRONG.**

5. For your personal safety, this appliance must be grounded. In the event of an electrical short circuit, grounding reduces the risk of electrical shock by providing an escape wire for the electric current. This appliance is equipped with a polarized 3-prong grounding plug. It must be plugged into a correctly polarized mating 3-prong grounding type wall receptacle, properly installed and grounded in accordance with the National Electrical Code and local codes and ordinances. If a mating wall receptacle is not available or if you are not sure if the wall receptacle is properly grounded and polarized, have it checked by a qualified electrician.

It is the personal responsibility and obligation of the customer to have a properly grounded and correctly polarized 3-prong wall receptacle installed by a qualified electrician.

Consult a qualified electrician if the grounding instructions are not completely understood, or if doubt exists as to whether the appliance is properly grounded.

It is not recommended to use an extension cord with your microwave oven, but if you find it necessary to do so temporarily (until a properly grounded and polarized, 3-prong receptacle is installed), use only a heavy duty, UL listed, 3-wire grounding type extension cord containing three 16-gauge (minimum) copper wires. It must not be longer than 10 feet (cords longer than 10 feet may affect the cooking performance of your microwave oven). The plug on the extension cord must fit into a 3-prong grounding type wall receptacle (as shown on this page) and the receptacle end of the extension cord must accept the 3-prong grounding plug of the microwave oven.

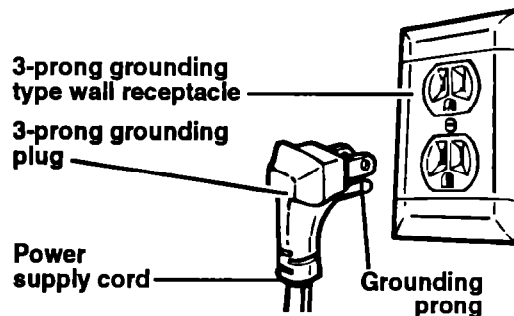

6.  To test the oven, plug it into the proper electrical outlet. Put about one cup (250 mL) of cold water in a glass container in the oven. Close the door. Make sure it latches. Follow the directions on page 20 to set the oven to cook for 2 minutes. When the time is up, the water should be heated.

7. **This microwave oven is designed for use in the household only and must not be used for commercial purposes.** Do not remove the door, control panel or cabinet at any time. The unit is equipped with high voltage and should be serviced by an authorized Whirlpool® service technician.

- SAVE THESE INSTRUCTIONS -

Getting To Know Your Microwave-Convection Oven

This section discusses the concepts behind microwave cooking and introduces you to the basics you need to know to operate your microwave oven. Please read this information before use.

In This Section	
	Page
How microwave cooking works	10
Microwave oven features	12
Control panel features	13
Built-in kits	15
Setting the clock	16
Using the Minute Timer	17

How microwave cooking works

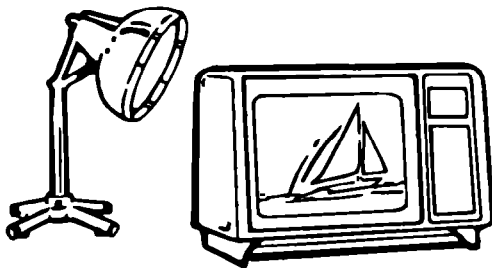

Microwave ovens are safe. Microwave energy is not hot. It causes food to make its own heat, and it's this heat that cooks the food.

Microwaves are like TV waves or light waves. You cannot see them, but you can see what they do.

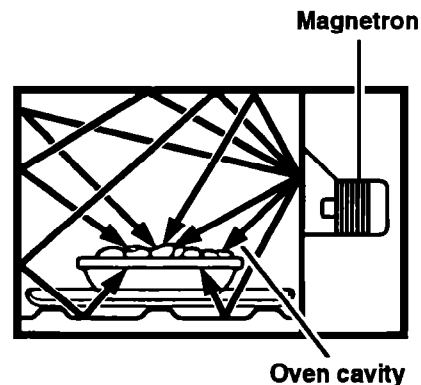

A magnetron in the microwave oven produces microwaves. The microwaves move into the oven where they contact food as it turns on the turntable.

GETTING TO KNOW YOUR MICROWAVE-CONVECTION OVEN

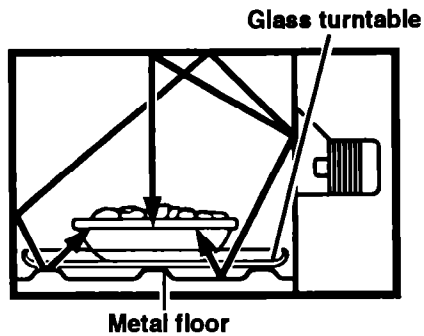

The ceramic glass turntable of your microwave oven lets microwaves pass through. Then they bounce off a metal floor, back through the ceramic glass turntable, and are absorbed by the food.

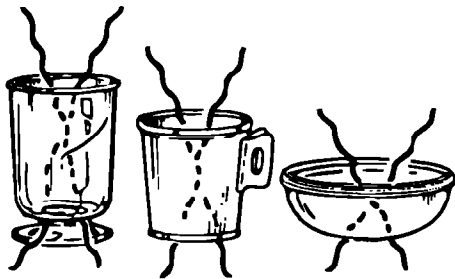

Microwaves pass through most glass, paper and plastics without heating them so food absorbs the energy. Microwaves bounce off metal pans so food does not absorb the energy.

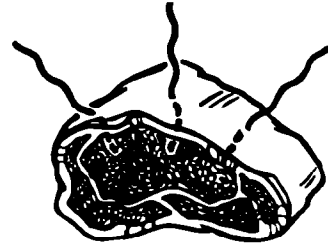

Microwaves may not reach the center of a roast. The heat spreads to the center from the outer, cooked areas just as in conventional cooking. This is one of the reasons for letting some foods (for example, roasts or baked potatoes) stand for a while after cooking, or for stirring some foods during the cooking time.

The microwaves disturb water molecules in the food. As the molecules bounce around bumping into each other, heat is made, like rubbing your hands together. This is the heat that does the cooking.

Microwave oven features

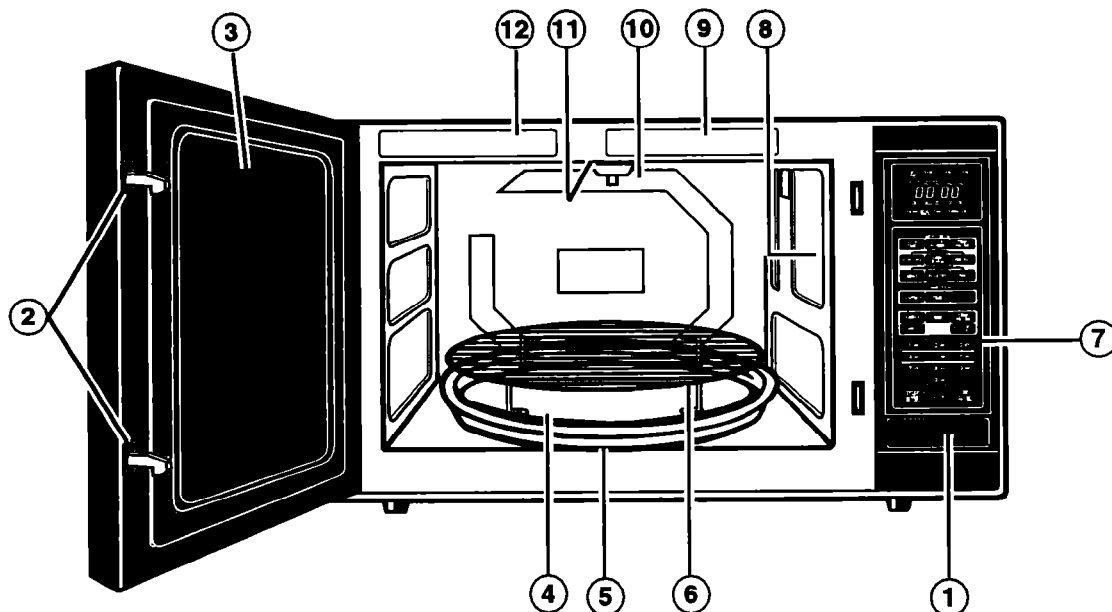

Your microwave oven is designed to make your cooking experience as enjoyable and productive as possible. To get you up and running quickly, the following is a list of the oven's basic features:

- 1. One-Touch Door Open Button.** Push to open door.
- 2. Door Safety Lock System.** The oven will not operate unless the door is securely closed.
- 3. Window with Metal Shield.** Shield prevents microwaves from escaping. It is designed as a screen to allow you to view food as it cooks.
- 4. Ceramic Glass Turntable.** This turntable turns food as it cooks for more even cooking. It must be in the oven during operation for best cooking results. See pages 7, 11 and 61 for more details.
- 5. Turntable Support (under turntable).**
- 6. Bi-Level Cooking Rack.** Use to convection or combination cook on two levels at the same time. Place one plate of food on the turntable and another above it on the rack.
- 7. Control Panel.** Touch pads on this panel to perform all functions. See pages 13 and 14 for more information.
- 8. Light.** Automatically turns on when door is opened or when oven is operating.
- 9. Cooking Guide Label.** Use as a quick reference for Reheat and Auto Combination settings.
- 10. Convection Air Openings.** See page 40 for information on convection cooking.
- 11. Temperature Probe Socket (top interior on oven ceiling).** Plug the Temperature Probe into this socket when using the probe to cook to a specific temperature. See pages 26, 47, and 55 for more information.
- 12. Model and Serial Number Plate.**

Control panel features

Your microwave oven control panel lets you select the desired cooking function quickly and easily. All you have to do is touch the necessary Command Pad. The following is a list of all the Command and Number Pads located on the control panel. For more information, see pages 16-60.

1. **Display.** This display includes a clock and indicators to tell you time of day, cooking time settings and cooking functions selected.
2. **COOK TIME.** Touch this pad followed by Number Pads to enter cooking times. See pages 20, 22, and 23 for more information.
3. **COOK POWER.** Touch this pad followed by a Number Pad to set the amount of microwave energy released to cook the food. The higher the number, the higher the power or "cooking speed." See page 21 for more information. See the charts on pages 62 and 63 for specific Cook Powers to use for the food you are cooking.
4. **TEMP PROBE (microwave).** Touch this pad when using the Temperature Probe to cook with microwaves. Touch TEMP PROBE followed by Number Pads to set the desired final food temperature, and COOK POWER followed by a Number Pad for the Cook Power you want. See page 27 for more information.
5. **POPCORN.** Touch this pad when popping popcorn in your microwave oven. The oven will automatically heat for a preset time at a preset Cook Power. See page 30 for more information.
6. **KEEP WARM.** Touch this pad to keep hot, cooked food safely warm in your microwave oven for up to 99 minutes, 99 seconds. KEEP WARM can be used by itself, or it can automatically follow a cooking cycle. See page 31 for more information.

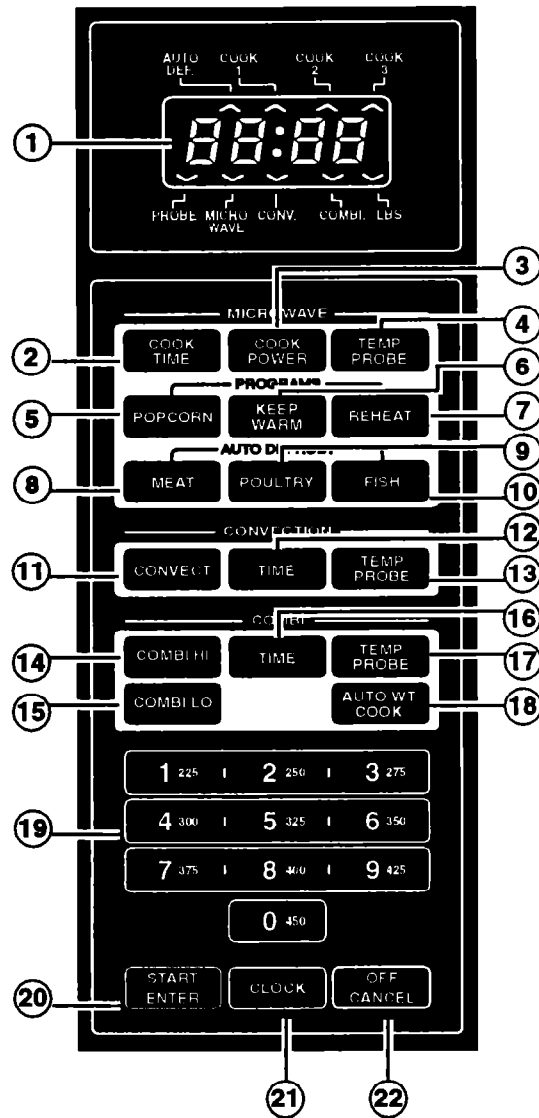

GETTING TO KNOW YOUR MICROWAVE-CONVECTION OVEN

7. **REHEAT.** Touch this pad to reheat many of your favorite foods automatically without setting a time or Cook Power. See page 33 for more information.
 8. **MEAT.** Touch this pad followed by Number Pads to thaw frozen meat by weight. See page 35 for more information.
 9. **POULTRY.** Touch this pad followed by Number Pads to thaw frozen poultry by weight. See page 35 for more information.
 10. **FISH.** Touch this pad followed by Number Pads to thaw frozen fish by weight. See page 35 for more information.
 11. **CONVECT.** Touch this pad to convection cook. See pages 41, 43, 44, and 48 for more information.
 12. **TIME (convection).** Touch this pad followed by Number Pads to enter a convection cooking time. See pages 42 and 44 for more information.
 13. **TEMP PROBE (convection).** Touch this pad when using the Temperature Probe to convection cook. Touch TEMP PROBE followed by Number Pads to set the desired final food temperature. Then set a convection cooking temperature. See page 48 for more information.
 14. **COMBI HI.** Touch this pad to combination cook with a convection temperature of 375°F and a percentage of microwave oven power. See page 53 for more information.
 15. **COMBI LO.** Touch this pad to combination cook with a convection temperature of 350°F and a percentage of microwave oven power. See page 53 for more information.
 16. **TIME (combination).** Touch this pad followed by Number Pads to set a combination cooking time. See page 53 for more information.
 17. **TEMP PROBE (combination).** Touch this pad when using the Temperature Probe to combination cook. Touch TEMP PROBE followed by Number Pads to set the desired final food temperature. Then set a combination cooking setting. See page 56 for more information.
 18. **AUTO WT. COOK.** Touch this pad followed by Number Pads to combination cook by weight. See page 59 for more information.
 19. **Number Pads.** Touch Number Pads to enter cooking times, temperatures, Cook Powers, and food weights.
 20. **START/ENTER.** Touch this pad to start a function that you have set. If you open the door after the oven begins to cook, retouch START/ENTER.
 21. **CLOCK.** Touch this pad to enter the correct time of day. See page 16 for more information.
 22. **OFF/CANCEL.** Touch this pad once to erase an incorrect command or twice to cancel a program during cooking. This pad will not erase time of day.
- NOTES:**
- If you touch two Command Pads for the same cycle (for example, POPCORN and KEEP WARM), the second command will cancel the first.
 - If you attempt to enter unacceptable instructions, "E" will appear in the Display and three tones will sound. Touch OFF/CANCEL and re-enter the instructions.

GETTING TO KNOW YOUR MICROWAVE-CONVECTION OVEN

Audible signals

Audible signals are available to guide you when setting and using your oven:

- A programming tone will sound each time you touch a pad.
- Three tones signal the end of a cooking cycle.

Interrupting cooking

You can stop the oven during a cycle by opening the door. The oven stops heating and the fan stops, but the light stays on.

To restart cooking, close the door and

TOUCH



If you do not want to continue cooking:

- Close the door and the light goes off.

OR

• TOUCH



Built-in kits

You can build in your microwave oven by using one of the following trim kits:

SIZE	COLOR	KIT MODEL NO.	KIT PART NO.	UL APPROVED FOR INSTALLATION OVER WHIRLPOOL OVEN MODEL
27"	Black	MK8137XAB	4378056	RB760PXY
30"	Black	MK8130XAB	4378058	RB260PXY, RB220PXY
27"	White	MK8137XAQ	4378055	RB760PXY
30"	White	MK8130XAQ	4378057	RB260PXY, RB220PXY

See page 8 for more information.

Setting the clock

When your microwave oven is first plugged in or after a power failure, the Display will only show “: 0”. If a time of day is not set, then the Display will start counting up from “0” until you set the cooking time or touch OFF/CANCEL.

NOTES:

- **You can** only set the clock if the oven is not cooking food.
- **If you touch** in an incorrect time, “E” will appear on the Display and three tones will sound. Touch CLOCK and enter the correct time.
- **If you touch** OFF/CANCEL while setting the clock, the clock will be cleared and the Display will go blank.

To set time:

1. Choose setting.

TOUCH



YOU SEE

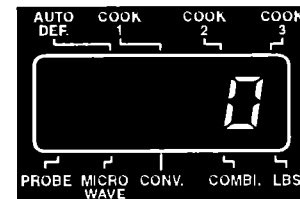

2. Enter time of day.

Example for 5:30:

TOUCH



YOU SEE



3. Complete entry.

TOUCH



YOU SEE



Using the Minute Timer

You can use the microwave oven controls as a minute timer. Use COOK TIME at "0" Cook Power for timing up to 99 minutes, 99 seconds.

NOTE: The oven will not operate while the Minute Timer is in use.

1. Touch COOK TIME.

TOUCH



YOU SEE

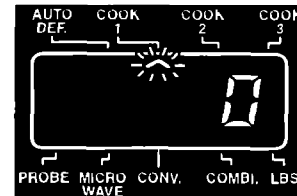

2. Enter time to be counted down.

Example for 1 minute, 30 seconds:

TOUCH



YOU SEE



3. Enter "0" Cook Power so oven does not start.

TOUCH



YOU SEE



TOUCH



YOU SEE



GETTING TO KNOW YOUR MICROWAVE-CONVECTION OVEN

4. Start countdown.

TOUCH



YOU SEE



After one second, the Display will begin to count down:

YOU SEE



At end of countdown:

YOU SEE



(three tones will sound)

5. After countdown, open the door.

OR

TOUCH



YOU SEE



(time of day)

Microwave Cooking

This section gives you instructions for operating each microwave function. Please read these instructions carefully.

In This Section			
	Page		Page
Getting the best cooking results	19	Using POPCORN	30
Microwave cooking at high cook power	20	Using KEEP WARM	31
Microwave cooking at lower cook powers	21	Using REHEAT	33
Microwave cooking with more than one cook cycle	23	Reheat chart	34
Microwave cooking with the temperature probe	26	Defrosting with microwave energy	35
		Auto defrost chart	37
		Defrosting tips	39

Getting the best cooking results

- **Although a new rating method*** rates this oven at 850 watts, you may use a reliable cookbook and recipes developed for microwave ovens previously rated at 700-800 watts.
- **ALWAYS cook** food for the minimum recommended cooking time. Then **check** for doneness to avoid overcooking the food.
- **Stir, turn over or rearrange food** being cooked about halfway through the cook time for most even doneness with all recipes.
- **If a glass cover is not available, use** wax paper, paper towels or microwave-approved plastic wrap. **Turn back** a corner to vent steam during cooking.

* IEC-705 Test Procedure. The IEC-705 Test Procedure is an internationally recognized method of rating microwave wattage output and does not represent an actual change to output power or cooking performance.

MICROWAVE COOKING

Microwave cooking at high cook power

1. Put food in oven and close the door.

2. Set cooking time.

TOUCH

COOK
TIME

YOU SEE

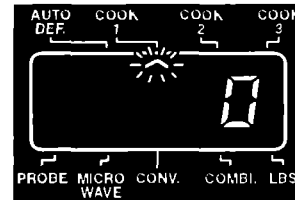

Example for 1 minute,
30 seconds:

TOUCH

1 225°

3 275°

0 450°

YOU SEE



3. Start oven.

TOUCH

START
ENTER

YOU SEE



After one second, the Display will begin to
count down the cooking time:

YOU SEE



At end of cooking time:

YOU SEE



(three tones will sound)

4. After cooking, open the door.

OR TOUCH



YOU SEE



(time of day)

Microwave cooking at lower cook powers

For best results, some recipes call for lower Cook Powers. The lower the Cook Power, the slower the cooking. Each Number Pad also stands for a different percentage of Cook Power. Many microwave cookbook recipes tell you by number, percent or name which Cook Power to use.

The following chart gives the percentage of Cook Power each Number Pad stands for, and the Cook Power name usually used. It also tells you when to use each Cook Power.

COOK POWER	NAME	WHEN TO USE IT
Automatic 100% of full power	HIGH	Quick reheating of foods with high water content, such as beverages. If food contains eggs or cream, choose a lower power.
9=90% of full power		Heating large quantities of liquids, such as water or soup stock.
8=80% of full power		Reheating soups or casseroles.
7=70% of full power	MED-HIGH	Cooking and heating vegetables, fish, meat, etc. when you need a Cook Power lower than HIGH or when food is cooking too fast.
6=60% of full power		Cooking requiring special care, such as for high protein sauces, cheese and egg dishes, and casseroles that need to finish cooking.
5=50% of full power	MED	Starting cakes which must be finished on HIGH power or finishing cooking of a large roast.
4=40% of full power		Simmering stews, reheating pastries.
3=30% of full power	MED-LOW, DEFROST	Defrosting of foods such as bread, shellfish, and precooked foods.
2=20% of full power		Defrosting and softening butter, cheese and ice cream.
1=10% of full power	LOW	Keeping one food serving warm.

MICROWAVE COOKING

1. Put food in oven and close the door.

2. Set cooking time.

TOUCH

**COOK
TIME**

YOU SEE

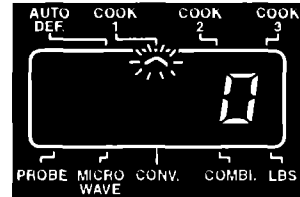

Example for 7 minutes, 30 seconds:

TOUCH

7 375°

3 275°

0 450°

YOU SEE

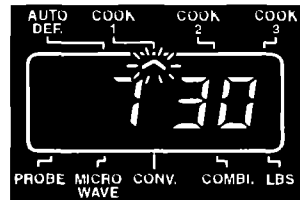

3. Set Cook Power.

TOUCH

**COOK
POWER**

YOU SEE



Example for 50% Cook Power:

TOUCH

5 325°

YOU SEE

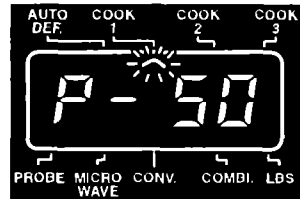

4. Start oven.

TOUCH

**START
ENTER**

YOU SEE



MICROWAVE COOKING

After one second, the Display will begin to count down the cooking time:

YOU SEE



At end of cooking time:

YOU SEE

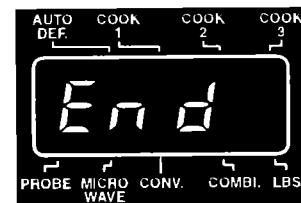

(three tones will sound)

5. After cooking, open the door.

OR TOUCH



YOU SEE



(time of day)

Microwave cooking with more than one cook cycle

For best results, some recipes call for one Cook Power for a certain length of time, and another Cook Power for another length of time. Your oven can be set to change from one to another automatically, for up to three

cycles. The examples shown in this section are for regular microwave cooking. However, you can also cook with more than one cook cycle when using other timed functions on your microwave-convection oven.

1. Put food in oven and close the door.

2. Set cooking time for first cycle.

TOUCH



YOU SEE

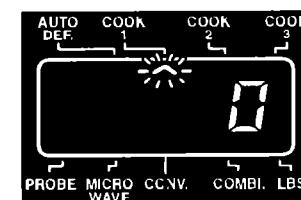

MICROWAVE COOKING

Example for 7 minutes, 30 seconds:

TOUCH

7 375°

3 275°

0 450°

YOU SEE

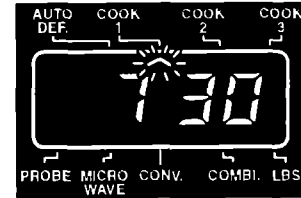

3. Set Cook Power for first cycle.

TOUCH

COOK
POWER

YOU SEE



Example for 50% Cook Power:

TOUCH

5 325°

YOU SEE



4. Repeat Steps 2 and 3 to set cooking time and Cook Power for each additional cycle.

5. Start oven.

TOUCH

START
ENTER

YOU SEE



(cycle 1 cook power)

After one second, the Display will begin to count down cycle 1 cooking time:

NOTE: The Display will show the set Cook Power for two out of every ten seconds.

YOU SEE



(two tones will sound between each cycle)

MICROWAVE COOKING

At end of cooking time:

YOU SEE

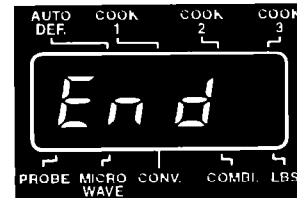

(three tones will sound)

6. After cooking, open the door.

OR TOUCH



YOU SEE



(time of day)

Changing or adding instructions

You can change times or Cook Powers or add cycles any time before touching START/ENTER:

1. Touch OFF/CANCEL.
2. Enter your new instructions.

Microwave cooking with the temperature probe

The Temperature Probe helps take the guesswork out of cooking roasts and larger casseroles. The probe is designed to turn off the oven when it senses the temperature you chose (between 90°F and 200°F). See your Cookbook for helpful information on cooking different types of food.

NOTE: If you have not plugged in Temperature Probe properly or if probe is defective, "PROB" will appear on the Display, three tones will sound, and the oven will not turn on.

1. Insert probe into food.

Insert at least $\frac{1}{3}$ of the Temperature Probe into the food. (See page 29.)

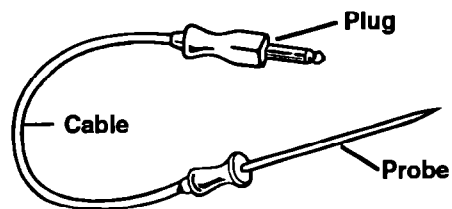

2. Place food in oven and plug probe into socket on oven ceiling.

Make sure the probe does not touch any part of the oven interior—including the turntable.

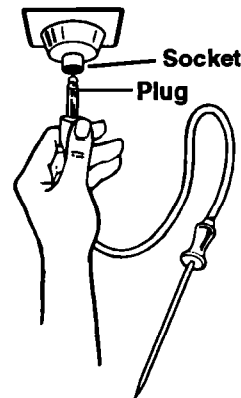

3. Close the door.

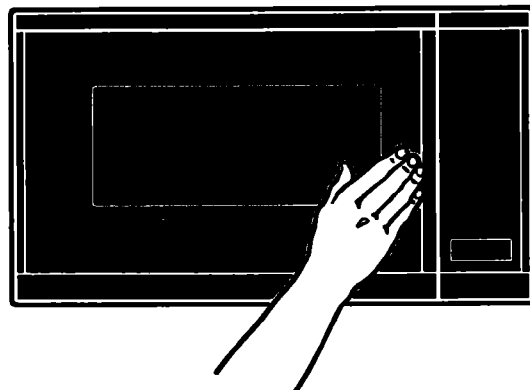

MICROWAVE COOKING

4. Choose setting.

TOUCH

TEMP
PROBE

YOU SEE

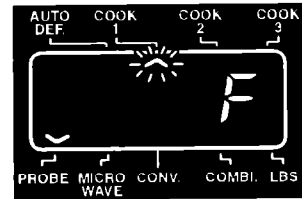

5. Set desired final food temperature.

Example for 180°:

TOUCH

1 225°

8 400°

0 450°

YOU SEE



6. Set Cook Power.

TOUCH

COOK
POWER

YOU SEE

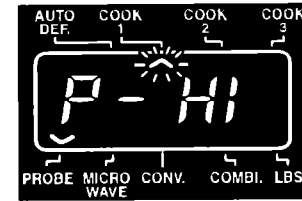

Example for 70% Cook Power:

TOUCH

7 375°

YOU SEE



MICROWAVE COOKING

7. Start oven.

TOUCH



YOU SEE

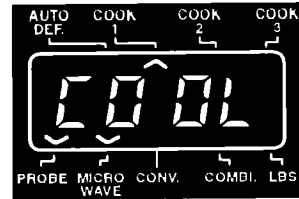

When food temperature reaches 90°F:

The Display will show the actual temperature of the food as it increases to the desired temperature. When the probe detects the desired food temperature, the oven will shut off.

YOU SEE



When food reaches desired temperature:

YOU SEE



(three tones will sound)

8. After cooking, open the door.

OR

TOUCH



NOTE: The Probe Indicator Light will continue to show until you remove the probe from the socket.

YOU SEE



(time of day)

Temperature Probe cooking tips:

- **Stir** foods during cooking when recommended.
- **Stir** soups, casseroles and drinks before serving.
- **Cover** roasts with foil after cooking and **let stand** a few minutes. **Remove** foil if you decide to cook roasts longer.
- **Remove** the probe from the oven when not cooking by temperature.

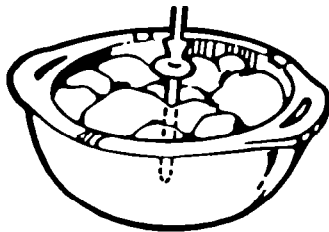

- **For casseroles**, the tip of the probe should be in the center of the food. **Stir** foods when recommended. **Replace** the probe.

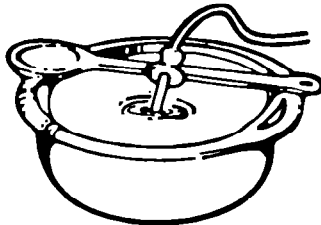

- **For liquids**, **balance** the probe on a wooden spoon or spatula so the tip of the probe is in the center of the liquid.

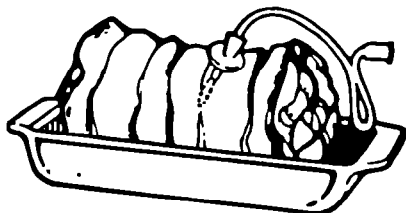

- **For roasts**, the tip of the probe should be in the center of the largest muscle, but not touching fat or bone.

- **Casseroles** cooked using the Temperature Probe should be made from precooked foods. **Do not use raw meats**, raw vegetables and cream sauces in casseroles.
- **Dry casseroles** do not work well.
- **Thaw** frozen casseroles and meats in the microwave oven before inserting the probe.
- **If you are cooking** more than one individual serving at the same time, such as mugs of soup, **check** the probe setting in several of the items—all the mugs may not heat at the same rate.
- **Dry meat loaf** mixtures do not work well.
- **Check poultry** with thermometer in 2-3 places to ensure adequate doneness.
- **Roasts may vary** in size, shape and composition. **Use** the Temperature Probe as a guide, along with the timings for minutes per pound found in the "Microwave cooking chart" on page 63.

Don't:

- **let probe or probe cable** touch any part of the oven interior (including the turntable).
- **let probe touch foil** (if used). You can keep foil away from probe with wooden toothpicks. **Remove** foil if arcing occurs.
- **use** paper, plastic wrap or plastic containers. They will be in the oven too long and might distort.
- **force** probe into frozen food.
- **use** probe for food that needs to simmer.
- **plug** the pointed end of the Temperature Probe into the socket.

Removing and cleaning the Temperature Probe:

1. After oven has shut off, **unplug** the Temperature Probe using an oven mitt or hot pad.
2. **Wipe** probe with a hot, sudsy cloth and **dry** thoroughly. **Use** a plastic scouring pad to remove cooked-on foods.
3. **You can place** probe in the silverware basket of a dishwasher.

Using POPCORN

POPCORN allows you to pop popcorn by touching just one pad and START/ENTER.

NOTES:

- **This setting** works well with most 3.5 oz bags of microwave popcorn. Cooking performance may vary with brand. Try several brands to decide which gives best popping results. For best results, use fresh bags of popcorn. Do not try to repop unpopped kernels. Do not reuse popcorn bags.
- **POPCORN** is designed for commercially bagged microwave popcorn. If you are using a microwave popcorn popper, follow instructions with the popper for cooking time.
- **Use** only one package at a time.
- **Use** only popcorn packages for microwave ovens.
- **If more time is needed**, cook in 20-second periods at high Cook Power. (See "Microwave cooking at high cook power" on page 20.)

1. Place bag on rack in center of turntable.

2. Choose setting.

TOUCH

POPCORN

YOU SEE



3. Start oven.

NOTE: The Display will show "PoP" for two out of every ten seconds.

TOUCH

START
ENTER

YOU SEE



(time counts down)

At end of cooking time:

YOU SEE



(three tones will sound)

4. After popping popcorn, open the door.

OR TOUCH

OFF
CANCEL

YOU SEE



(time of day)

Using KEEP WARM

You can safely keep hot, cooked food warm in your microwave oven for up to 99 minutes, 99 seconds (about 1 hour, 40 minutes). You can use KEEP WARM by itself, or to automatically follow a cooking cycle.

NOTES:

- **KEEP WARM** operates for up to 99 minutes, 99 seconds.
- **Opening** the oven door cancels KEEP WARM. Close the door and touch KEEP WARM, then touch START/ENTER if additional KEEP WARM time is desired.
- **Food cooked covered** should be covered during KEEP WARM.
- **Pastry items** (pies, turnovers, etc.) should be uncovered during KEEP WARM.
- **Complete meals** kept warm on a dinner plate should be covered during KEEP WARM.
- **Do not use** more than one complete KEEP WARM cycle (about 1 hour, 40 minutes). The quality of some foods will suffer with extended time.

1. Put hot, cooked food in oven and close the door.

2. Choose setting.

TOUCH

KEEP
WARM

YOU SEE



MICROWAVE COOKING

3. Start oven.

TOUCH



YOU SEE

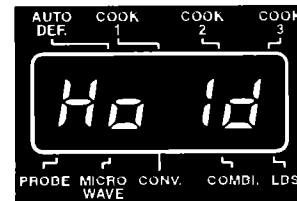

(the oven light and fan will come on)

To make **KEEP WARM** automatically follow another cycle:

- While you are touching in cooking instructions, touch **KEEP WARM** before touching **START/ENTER**.
OR
- After the oven starts operating, touch **OFF/CANCEL** once, touch **KEEP WARM** and then touch **START/ENTER**.
- When the last cooking cycle is over, you will hear two tones. "Hold" will come on while the oven continues to run.
- **KEEP WARM** will follow **AUTO DEFROST**, **COOK**, or **Temperature Probe** cooking.

Using REHEAT

You can reheat many foods by touching just one pad and START/ENTER. You do not need to calculate cooking time or Cook Power.

1. Put food in oven and close the door.

2. Choose setting.

Touch REHEAT one to three times depending on the category of food you are reheating. (See "Reheat chart" on page 34.)

TOUCH



once
(example)

YOU SEE

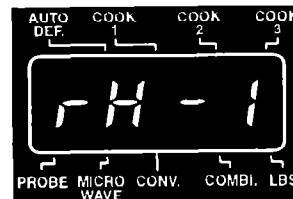

3. Start oven.

NOTE: The Display will show the selected reheat setting for two out of every ten seconds.

TOUCH



YOU SEE



(time counts down)

At end of reheating time:

YOU SEE

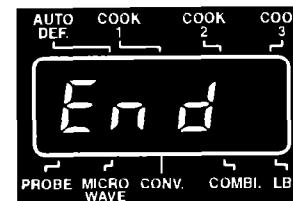

(three tones will sound)

4. After reheating, open the door.

OR TOUCH



twice

YOU SEE



(time of day)

MICROWAVE COOKING

Reheat chart

SETTING	CATEGORY	FOOD	AMOUNT
1	Baked Goods	Yeast Rolls Fruit Pie Muffins Sweet Rolls	2-3 rolls, 6-8 oz total 1 slice, 6-8 oz 1 lg or 2-3 sm, 3-4 oz total 1-2 rolls, 6-8 oz total
2	Single Serve/Light	Quiche Cooked Rice Hot Cereal	1 slice, 4-5 oz ¾ cup, 8-10 oz 1 serving
3	Single Serve/ Dense	Lasagna, Meat and Sauce Lasagna, Vegetable and Cheese Macaroni and Cheese Plate of Food	8 oz 6 oz 8 oz

Defrosting with microwave energy

Your microwave oven automatically defrosts a variety of common meats at preset Cook Powers for preset times. The 2-stage defrost cycle is programmed for meat, poultry, and fish. All you do is touch the Command

Pad assigned to the desired category and enter the weight of the items being defrosted. Your microwave oven does the rest.

NOTE: See the "Auto defrost chart" on page 37 for defrosting directions for each food.

1. Put frozen food in oven and close the door.

2. Choose setting.

Example for MEAT:

TOUCH



YOU SEE



3. Enter food's weight (in pounds and tenths of a pound).

Example for 2.5 lbs:

TOUCH



YOU SEE



4. Start oven.

TOUCH



YOU SEE



(time counts down)

MICROWAVE COOKING

5. After first stage is completed, five tones will sound.

Open door, turn over meat, and shield any warm portions.

NOTE: If you do not do this step, the oven will continue cooking.

YOU SEE



6. Restart oven.

TOUCH

START
ENTER

YOU SEE



(countdown continues)

At end of defrosting time:

YOU SEE



(three tones will sound)

7. After defrosting, open the door.

OR TOUCH

OFF
CANCEL

YOU SEE



(time of day)

Auto defrost chart

Meat setting

FOOD	AT PAUSE	SPECIAL INSTRUCTIONS
Beef		Meat of irregular shape and large, fatty cuts of meat should have the narrow or fatty areas shielded with foil at the beginning of a defrost cycle.
Ground Beef, Bulk	Remove thawed portions with fork. Turn over. Return remainder to oven.	Do not defrost less than 1/4 lb. Freeze in doughnut shape.
Ground Beef, Patties	Separate and rearrange.	Do not defrost less than two 4 oz patties. Depress center when freezing.
Round Steak	Turn over. Cover warm areas with aluminum foil.	Place on a microwavable roasting rack.
Tenderloin Steak	Turn over. Cover warm areas with aluminum foil.	Place on a microwavable roasting rack.
Stew Beef	Remove thawed portions with fork. Separate remainder. Return remainder to oven.	Place in a microwavable baking dish.
Pot Roast, Chuck Roast	Turn over. Cover warm areas with aluminum foil.	Place on a microwavable roasting rack.
Rib Roast	Turn over. Cover warm areas with aluminum foil.	Place on a microwavable roasting rack.
Rolled Rump Roast	Turn over. Cover warm areas with aluminum foil.	Place on a microwavable roasting rack.
Lamb		
Cubes for Stew	Remove thawed portions with fork. Return remainder to oven.	Place in a microwavable baking dish.
Chops (1 inch thick)	Separate and rearrange.	Place on a microwavable roasting rack.
Pork		
Chops (1/2 inch thick)	Separate and rearrange.	Place on a microwavable roasting rack.
Hot Dogs	Separate and rearrange.	Place on a microwavable roasting rack.
Spareribs, Country-Style Ribs	Turn over. Cover warm areas with aluminum foil.	Place on a microwavable roasting rack.
Sausage, Links	Separate and rearrange.	Place on a microwavable roasting rack.
Sausage, Bulk	Remove thawed portions with fork. Turn over. Return remainder to oven.	Place in a microwavable baking dish.
Loin Roast, Boneless	Turn over. Cover warm areas with aluminum foil.	Place on a microwavable roasting rack.

MICROWAVE COOKING

Auto defrost chart (continued)

Fish setting

FOOD	AT PAUSE	SPECIAL INSTRUCTIONS
Fish		
Fillets	Turn over. Separate fillets when partially thawed.	Place in a microwavable baking dish. Carefully separate fillets under cold water.
Steaks	Separate and rearrange.	Place in a microwavable baking dish. Run cold water over to finish defrosting.
Whole	Turn over.	Place in a microwavable baking dish. Cover head and tail with foil; do not let foil touch sides of microwave oven. Finish defrosting by immersing in cold water.
Shell Fish		
Crabmeat	Break apart. Turn over.	Place in a microwavable baking dish.
Lobster Tails	Turn over and rearrange.	Place in a microwavable baking dish.
Shrimp	Separate and rearrange.	Place in a microwavable baking dish.
Scallops	Separate and rearrange.	Place in a microwavable baking dish.

Poultry setting

FOOD	AT PAUSE	SPECIAL INSTRUCTIONS
Chicken		
Whole (up to 9½ lbs)	Turn over (finish defrosting breast-side down). Cover warm areas with aluminum foil.	Place chicken breast-side up on a microwavable roasting rack. Finish defrosting by immersing in cold water. Remove giblets when chicken is partially defrosted.
Cut Up	Separate pieces and rearrange. Turn over. Cover warm areas with aluminum foil.	Place on a microwavable roasting rack. Finish defrosting by immersing in cold water.
Cornish Hens		
Whole	Turn over. Cover warm areas with aluminum foil.	Place on a microwavable roasting rack. Finish defrosting by immersing in cold water.
Turkey		
Breast (under 6 lbs)	Turn over. Cover warm areas with aluminum foil.	Place on a microwavable roasting rack. Finish defrosting by immersing in cold water.

Weight conversion chart

You are probably used to food weights as being in pounds and ounces that are fractions of a pound (for example 4 ounces equals $\frac{1}{4}$ pound). However, in order to enter food weight in AUTO DEFROST, you must specify pounds and tenths of a pound.

If the weight on the food package is in fractions of a pound, you can use the following chart to convert the weight to decimals.

NUMBER AFTER DECIMAL	EQUIVALENT OUNCE WEIGHT
.10	1.6
.20	3.2
.25 One-Quarter Pound	4.0
.30	4.8
.40	6.4
.50 One-Half Pound	8.0
.60	9.6
.70	11.2
.75 Three-Quarters Pound	12.0
.80	12.8
.90	14.4
1.00 One Pound	16.0

Defrosting tips

- **When using AUTO DEFROST**, the weight to be entered is the net weight in pounds and tenths of pounds (the weight of the food minus the container).
- **Only use AUTO DEFROST** for raw food. AUTO DEFROST gives best results when food to be thawed is a minimum of 0°F (taken directly from a “true” freezer). If food has been stored in a refrigerator-freezer that does not maintain a temperature of 0°F or below, always program a lower food weight (for a shorter defrosting time) to prevent cooking the food.
- **If the food is stored outside** the freezer for up to 20 minutes, enter a lower food weight.
- **If the food is stored outside** the freezer for more than 20 minutes, and for defrosting ready-made food, defrost by time and power and let stand after defrosting.
- **The shape of the package** alters the defrosting time. Shallow rectangular packets defrost more quickly than a deep block.
- **Separate pieces** as they begin to defrost. Separated pieces defrost more easily.
- **You can use small pieces** of aluminum foil to shield foods like chicken wings, leg tips, and fish tails, but the foil must not touch the side of the oven. Foil can damage the oven lining.
- **Shield areas of food** with small pieces of foil if they start to become warm.
- **For better results, a preset standing time** is included in the defrosting time. This may make the defrosting time seem longer than expected. (For more information on standing time, see “Microwave cooking tips” on page 64.)

Convection Cooking

This section gives you instructions for operating each convection function. Please read these instructions carefully.

In This Section		Page	Page
How convection cooking works	40	Convenience foods cooking chart ..	46
Convection cooking without preheating	41	Convection cooking with the temperature probe	47
Convection cooking with preheating	43	Temperature probe convection cooking chart	50

How convection cooking works

Convection cooking circulates hot air through the oven cavity with a fan. The constantly moving air surrounds the food to heat the outer portion quickly. Your oven uses convection cooking whenever you use the Convection Command Pads. **DO NOT USE THE OVEN WITHOUT THE TURNTABLE IN PLACE.**

Helpful hints for convection cooking:

- **You can cook** food either directly on the turntable or with the Bi-Level Cooking Rack on the turntable.
- **Do not cover** turntable or baking rack with aluminum foil. It interferes with the flow of air that cooks the food.
- **Round pizza pans** are excellent cooking utensils for many convection-only items. Choose pans that do not have extended handles.
- **You may remove** the turntable when preheating the oven and when preparing food to be cooked directly on the turntable.
- **Use convection cooking** for items like souffles, breads, cookies, angel food cakes, pizza, and for some meat and fish cooking.
- **You do not need to use** any special techniques to adapt your favorite oven recipes to convection cooking; however, you may need to lower some temperatures

or reduce some cooking times from the convection oven cooking directions. See examples in your Cookbook and in the charts in this section.

- **When baking** cakes, cookies, breads, rolls or other baked foods, most recipes call for preheating. Preheat the empty oven just as you do a regular oven. You can start heavier dense foods such as meats, casseroles, and poultry without preheating.
- **All heatproof** cookware or metal utensils can be used in convection cooking.
- **As in conventional cooking**, the distance of the food from the heat source affects cooking results. Follow Cookbook recipes and refer to the charts in this Use and Care Guide. It is also helpful to find a similar recipe in the Cookbook index and to refer to recipes' suggested techniques.
- **Use metal utensils** only for convection cooking. Never use for microwave or combination cooking since arcing and damage to the oven may occur.
- **After preheating**, if you do not open the door, the oven will automatically hold at the preheated temperature for 30 minutes.
- **You can set up** to three convection cycles. (Example for two crust pies: you can set the oven to preheat for baking at 425°F and to finish baking at 350°F.)

⚠ WARNING

Burn Hazard

- To prevent burns, use oven mitts to remove hot cooking utensils, hot cooking rack, and hot turntable. In convection cooking, the circulated hot air heats the interior surfaces of the oven to very high temperatures.
- Use care to prevent burns whenever oven is in operation. The oven vent openings and surfaces near these openings, the oven door glass, door trim, etc. and interior oven surfaces could become hot enough to burn. Do not touch, or allow clothing or other flammable materials to contact these surfaces during or after use, until they have had time to cool.
- Use cooking utensils that will not melt or burn in the hot oven. Do not use light plastic containers, plastic wraps or paper products during any convection combination cycle. Failure to follow these guidelines could result in burns.

Convection cooking without preheating (meats, casseroles and poultry)

1. Put food in oven and close the door.

2. Choose setting.

Oven will automatically cook at 350°F.

TOUCH

CONVECT

YOU SEE



3. Set cooking temperature
(optional).

Example for 325°:

TOUCH

5 325°

YOU SEE



CONVECTION COOKING

4. Set cooking time.

TOUCH
CONVECTION

TIME

YOU SEE

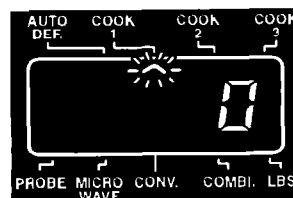

Example for 20 minutes:

TOUCH

2 250° 0 450°
0 450° 0 450°

YOU SEE

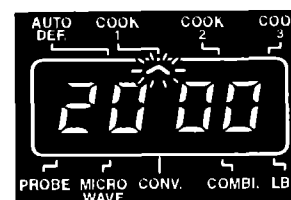

5. Start oven.

TOUCH

START
ENTER

YOU SEE



(time will count down)

At end of cooking time:

YOU SEE

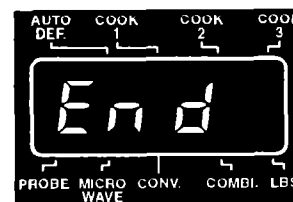

(three tones will sound)

6. After cooking, open the door.

OR

TOUCH

OFF
CANCEL

YOU SEE



(time of day)

Convection cooking with preheating

1. Choose setting.

The oven will automatically preheat at 350°F. If you want to change the preheat temperature, follow Step 2 below. If you want to preheat at 350°F, skip Step 2.

TOUCH

CONVECT

YOU SEE



2. Set preheat temperature (optional).

Example for 325°:

TOUCH

5 325°

YOU SEE



3. Set cooking cycle cooking temperature.

TOUCH

CONVECT

YOU SEE



Example for 300°:

TOUCH

4 300°

YOU SEE



CONVECTION COOKING

4. Set cooking cycle cooking time.

TOUCH
CONVECTION

TIME

YOU SEE

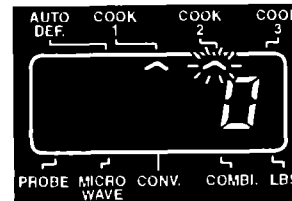

Example for 20 minutes:

TOUCH

2 250° 0 450°
0 450° 0 450°

YOU SEE



5. Start oven.

NOTE: If you want to set another cooking cycle, repeat Steps 3 and 4.

TOUCH

START
ENTER

YOU SEE

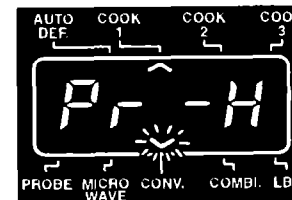

(display shows oven is preheating)

NOTES:

- If you open the door or touch OFF/CANCEL during preheating, preheating will stop. To resume preheating, close the door and touch START/ENTER.
- When the oven reaches the set preheat temperature, two tones will sound and the oven will automatically hold that temperature for 30 minutes. The Display will show the Hold Time counting down.

CONVECTION COOKING

6. After preheating, open the door, put food in oven and close the door.

NOTE: The oven temperature drops very quickly when the door is opened; however, this should not prevent food from being fully cooked during normal cooking time.

At end of cooking time:

TOUCH

START
ENTER

YOU SEE



(time for cook cycle will count down)

YOU SEE

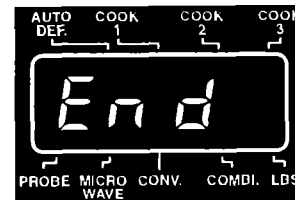

(three tones will sound)

7. After cooking, open the door.

OR

TOUCH

OFF
CANCEL

YOU SEE



(time of day)

CONVECTION COOKING

Convenience foods cooking chart

Convection cooking of convenience foods is similar to cooking in a conventional oven. Select items that fit conveniently on the turntable, such as an 8½-inch frozen pizza. Convection preheat to the desired temperature, and use metal or ovenproof glass cooking utensils. When cooking or baking these convenience foods, follow package

directions for preparation and selecting the correct container. Because of the great variety of foods available, times given here are approximate. It is advisable to always check food about five minutes before the minimum recommended time, and cook longer only if needed. Use oven mitts to insert or remove items from the oven.

FOOD	SIZE/WT	COOKING MODE	COOKING TIME	SPECIAL INSTRUCTIONS
Pizza (frozen)	13 ounces (8½ inch)	CONVECTION 400°F (preheated)	14-16 minutes	Cook directly on Bi-Level Cooking Rack for crisper crust.
Brownies	20 ounces	CONVECTION 350°F (preheated)	23-26 minutes	Bake in 9-inch square pan on Bi-Level Cooking Rack.
Frozen Double Crust Pie	26 ounces	CONVECTION 425°F (preheated) then 350°F	30 minutes 30-35 minutes	Bake in metal or ovenproof pan on Bi-Level Cooking Rack.
Cake Layers	18-25 ounces	CONVECTION 350°F (preheated)	20 minutes	Bake one layer at a time on Bi-Level Cooking Rack.
Apple Sauce Cake	18-25 ounces	CONVECTION 350°F (preheated)	30-35 minutes	Use metal 10-cup fluted tube pan on Bi-Level Cooking Rack.
Date Nut Bread	17 ounces	CONVECTION 350°F (preheated)	40 minutes	Bake in 9 x 5-inch metal loaf pan on Bi-Level Cooking Rack.
Frozen Bread Dough	16 ounces	CONVECTION 375°F (preheated)	25-30 minutes	Follow package directions for thawing and proofing dough. Bake in metal greased 8½ x 4½ x 2½-inch loaf pan on Bi-Level Cooking Rack.
Refrigerated Cookies	20 ounces	CONVECTION 350°F (preheated)	8-9½ minutes	Bake six at a time on metal round cookie sheet on Bi-Level Cooking Rack.

Convection cooking with the temperature probe

The Temperature Probe helps take the guesswork out of cooking roasts and larger casseroles. The probe is designed to turn off the oven when it senses the temperature you chose (between 90°F and 200°F). See your Cookbook for helpful information on cooking different types of food.

NOTE: If you have not plugged in the Temperature Probe properly or if probe is defective, "PROB" will appear on the Display, three tones will sound, and the oven will not turn on.

1. Insert probe into food.

Insert at least $\frac{1}{3}$ of the Temperature Probe into the food. (See page 29.)

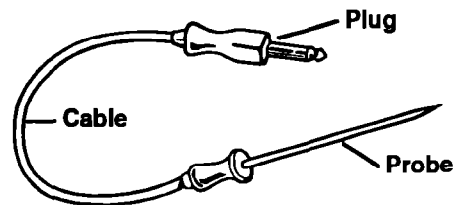

2. Place food in oven and plug probe into socket on oven ceiling.

Make sure the probe does not touch any part of the oven interior—including the turntable.

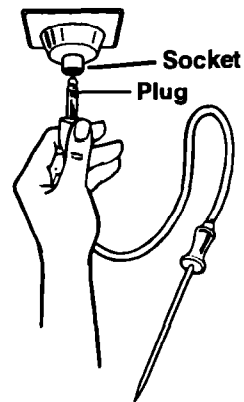

3. Close the door.

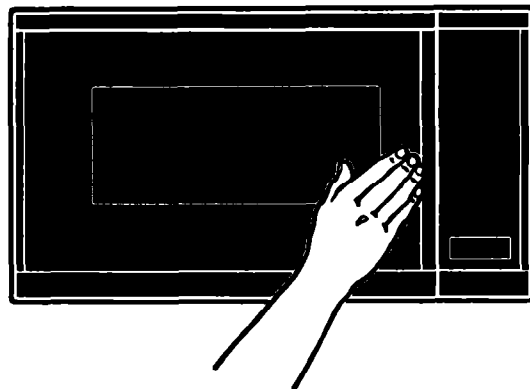

CONVECTION COOKING

4. Choose setting.

TOUCH
CONVECTION
TEMP
PROBE

YOU SEE

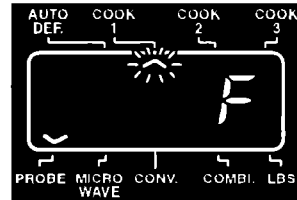

5. Set desired final food temperature.

Example for 150°:

TOUCH
1 225°
5 325°
0 450°

YOU SEE



6. Set convection cooking temperature.

TOUCH
CONVECT

YOU SEE



Example for 325°:

TOUCH
5 325°

YOU SEE



CONVECTION COOKING

7. Start oven.

When food temperature reaches 90°F, the Display will show the actual temperature of the food as it increases to the desired temperature.

TOUCH

START
ENTER

YOU SEE



When food reaches desired temperature:

YOU SEE

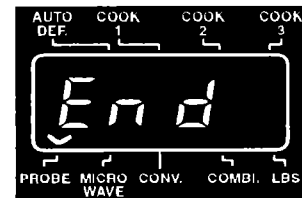

(three tones will sound)

8. After cooking, open the door.

OR

TOUCH

OFF
CANCEL

NOTE: The Probe Indicator Light will continue to show until you remove the probe from the socket.

YOU SEE



(time of day)

Temperature probe convection cooking chart

FOOD	OVEN TEMP	FIRST STAGE	SECOND STAGE		SPECIAL NOTES
		TIME	TIME	or PROBE TEMP	
Beef Meat Loaf (1½-1¾ lbs)	350°		35 min	160°F	Preheat. Let stand 5-10 min.
Beef Rib Roast, boneless	350°	5 min per lb Turn over	6 min per lb	Rare: 120°F Med: 130°F	Cook in microwave-proof and heatproof dish with Bi-Level Cooking Rack. Let stand 10 min after cooking (covered).
Beef Rib Roast, with bone (5 lbs)	350°	7 min per lb Fat-side down Turn over	8-10 min per lb	Rare: 120°F Med: 130°F Well: 140°F	Cook in microwave-proof and heatproof dish. Let stand 10 min after cooking (covered).
Beef Pot Roast, boneless (3 lbs)	350°	7 min per lb Turn over	8-10 min per lb	Med: 130°F Well: 140°F	Cook in covered microwaveproof and heatproof casserole or cooking bag.
Lamb Lamb Leg or Shoulder Roast, with bone (6½ lbs)	350°	4 min per lb Fat-side down Turn over	5-7 min per lb	Rare: 145°F Med: 155°F Well: 165°F	Cook in microwave-proof and heatproof dish with Bi-Level Cooking Rack. Let stand 10 min after cooking (covered).
Lamb Roast, boneless (3-4 lbs)	350°	5 min per lb Fat-side down Turn over	4-6 min per lb	150°F	Cook in microwave-proof and heatproof dish with Bi-Level Cooking Rack. Let stand 10 min after cooking (covered).

CONVECTION COOKING

FOOD	OVEN TEMP	FIRST STAGE	SECOND STAGE		SPECIAL NOTES
		TIME	TIME	or PROBE TEMP	
Veal Shoulder or Rump Roast, boneless (3-3½ lbs)	325°	4-5 min per lb Turn over	4-6 min per lb	155°F	Cook in microwave-proof and heatproof dish with Bi-Level Cooking Rack. Let stand 10 min after cooking (covered).
Pork Pork Loin Roast, boneless (4-5 lbs)	350°	5-7 min per lb Turn over	6-8 min per lb	165°F	Cook in microwave-proof and heatproof baking dish. Let stand 10 min after cooking (covered).
Pork Loin, center cut (4-5 lbs)	350°	5-7 min per lb Turn over	6-8 min per lb	165°F	Cook in microwave-proof and heatproof baking dish. Let stand 10 min after cooking (covered).

Combination Cooking

This section gives you instructions for operating each combination cooking function. Please read these instructions carefully.

In This Section		Page	Page
How combination cooking works ...	52	Temperature probe combination cooking chart	57
Combination HI and LO cooking	53	Auto weight combination cooking ..	59
Combination cooking with the temperature probe	55	Auto combination setting chart	60

How combination cooking works

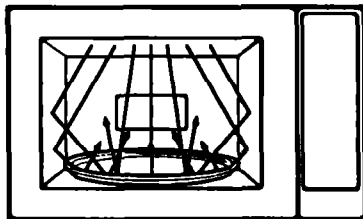

Microwave

+

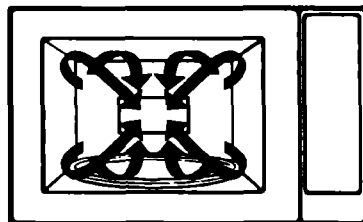

Convection

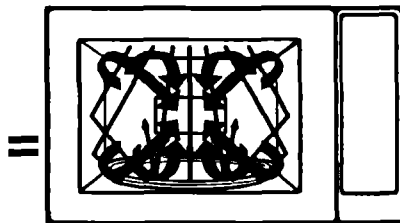

=
Combination microwave/convection

Sometimes combination microwave-convection cooking is suggested to get the proper cooking results. It shortens the cooking time for foods that normally need a long time to cook. This cooking process also leaves meats juicy on the inside and crispy on the outside. In combination cooking, the convection heat and microwave energy alternate

automatically. Your oven has two preprogrammed settings that make it easy to cook with both convection heat and microwave energy automatically.

Helpful hints for combination cooking:

1. **Meats** may be roasted directly on the Bi-Level Cooking Rack or in a shallow roasting pan placed on the rack, on the turntable. When using the Bi-Level Cooking Rack, please check your Cookbook for information on proper use.
2. **Less tender** cuts of beef can be roasted and tenderized using oven cooking bags.
3. **When baking**, check for doneness after cooking time is up. If not completely done, let stand in oven for a few minutes to complete cooking.

NOTE: During combination baking, some baking utensils may cause arcing when they come in contact with the turntable, oven walls or metal accessory racks. Arcing is a discharge of electricity that occurs when microwaves come in contact with metal. If arcing occurs, place a heatproof dish between the pan and the turntable or Bi-Level Cooking Rack. If arcing occurs with other baking utensils, discontinue their use for combination cooking.

Combination HI and LO cooking

COMBI HI lets you cook with microwaves for 8 seconds and convection for 14 seconds at 375°F.

COMBI LO lets you cook with microwaves for 8 seconds and convection for 14 seconds at 350°F.

1. Put food in oven and close the door.

2. Choose setting.

Example for HI:

TOUCH

COMBI HI

YOU SEE

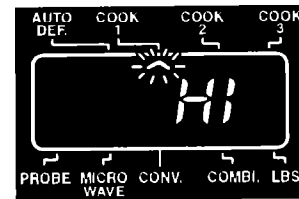

3. Set cooking time.

TOUCH

COMBI

TIME

YOU SEE

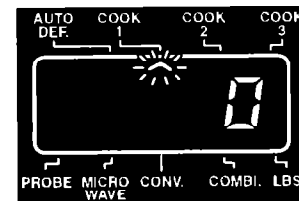

Example for 15 minutes, 30 seconds:

TOUCH

1 225°

5 325°

3 275°

0 450°

YOU SEE



4. Start oven.

TOUCH

START
ENTER

YOU SEE



COMBINATION COOKING

At end of cooking time:

YOU SEE

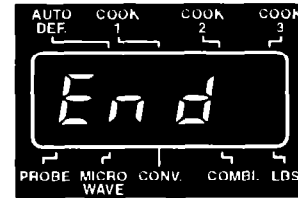

(three tones will sound)

5. After cooking, open the door.

OR TOUCH



YOU SEE



(time of day)

Combination cooking with the temperature probe

The Temperature Probe helps take the guesswork out of cooking roasts and larger casseroles. The probe is designed to turn off the oven when it senses the temperature you chose (between 90°F and 200°F). See your Cookbook for helpful information on cooking different types of food.

NOTES:

- If you have not plugged in the Temperature Probe properly or if probe is defective, "PROB" will appear on the Display, three tones will sound, and the oven will not turn on.
- For correct probe temperatures for different foods, see the "Temperature probe combination cooking chart" on page 57.

1. Insert probe into food.

Insert at least $\frac{1}{2}$ of the Temperature Probe into the food. (See page 29.)

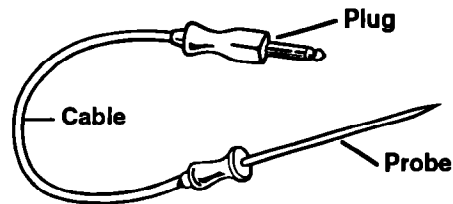

2. Place food in oven and plug probe into socket on oven ceiling.

Make sure the probe does not touch any part of the oven interior—including the turntable.

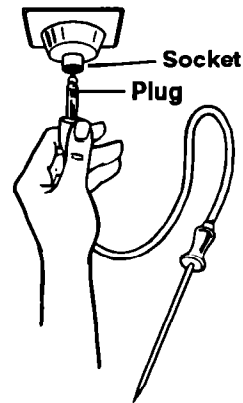

3. Close the door.

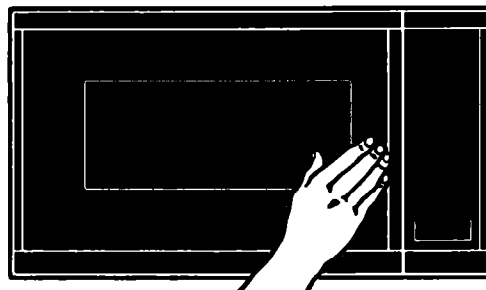

COMBINATION COOKING

4. Choose setting.

TOUCH
COMBI
TEMP
PROBE

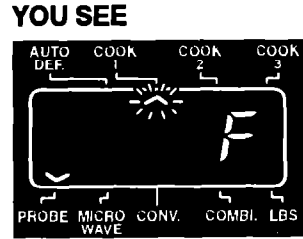

5. Set desired final food temperature.

Example for 150°:

TOUCH
1 225°
5 325°
0 450°



6. Choose combination cooking setting.

Example for HI:

TOUCH
COMBI HI

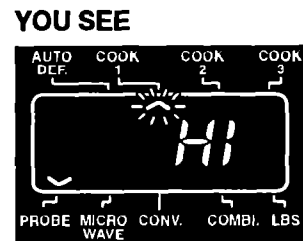

7. Start oven.

When food temperature reaches 90°F, the Display will show the actual temperature of the food as it increases to the desired temperature. When the probe detects the desired food temperature, the oven will shut off.

When food reaches desired temperature:

TOUCH
START
ENTER

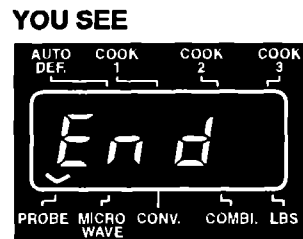

COMBINATION COOKING

8. After cooking, open the door.

OR TOUCH

NOTE: The Probe Indicator Light will continue to show until you remove the probe from the socket.

OFF
CANCEL

YOU SEE



(time of day)

Temperature probe combination cooking chart

FOOD	COMBI-NATION	FIRST STAGE	SECOND STAGE		SPECIAL NOTES
		TIME	TIME	or PROBE TEMP	
Beef Meat Loaf (1½-1¾ lbs)	HIGH		35 min	160°F	Preheat. Let stand 5-10 min.
Beef Rib Roast, boneless	LOW	5 min per lb Turn over	6 min per lb	Rare: 120°F Med: 130°F	Cook in microwave-proof and heatproof dish with Bi-Level Cooking Rack. Let stand 10 min after cooking (covered).
Beef Rib Roast, with bone (5 lbs)	LOW	7 min per lb Fat-side down Turn over	8-10 min per lb	Rare: 120°F Med: 130°F Well: 140°F	Cook in microwave-proof and heatproof dish. Let stand 10 min after cooking (covered).
Beef Pot Roast, boneless (3 lbs)	LOW	7 min per lb Turn over	8-10 min per lb	Med: 130°F Well: 140°F	Cook in covered microwaveproof and heatproof casserole or cooking bag.
Lamb Lamb Leg or Shoulder Roast, with bone (6½ lbs)	LOW	4 min per lb Fat-side down Turn over	5-7 min per lb	Rare: 145°F Med: 155°F Well: 165°F	Cook in microwave-proof and heatproof dish with Bi-Level Cooking Rack. Let stand 10 min after cooking (covered).

continued on next page

COMBINATION COOKING

FOOD	COMBINATION	FIRST STAGE	SECOND STAGE		SPECIAL NOTES
		TIME	TIME	or PROBE TEMP	
Lamb Roast, boneless (3-4 lbs)	LOW	5 min per lb Fat-side down Turn over	4-6 min per lb	150°F	Cook in microwave-proof and heatproof dish with Bi-Level Cooking Rack. Let stand 10 min after cooking (covered).
Veal Shoulder or Rump Roast, boneless (3-3½ lbs)	LOW	4-5 min per lb Turn over	4-6 min per lb	155°F	Cook in microwave-proof and heatproof dish with Bi-Level Cooking Rack. Let stand 10 min after cooking (covered).
Pork Pork Loin Roast, boneless (4-5 lbs)	LOW	5-7 min per lb Turn over	6-8 min per lb	165°F	Cook in microwave-proof and heatproof baking dish. Let stand 10 min after cooking (covered).
Pork Loin, center cut (4-5 lbs)	LOW	5-7 min per lb Turn over	6-8 min per lb	165°F	Cook in microwave-proof and heatproof baking dish. Let stand 10 min after cooking (covered).

COMBINATION COOKING

Auto weight combination cooking

Auto weight combination cooking lets you combination cook by simply touching one Command Pad and one Number Pad, and entering the food's weight. There are seven cooking settings from which to choose,

each preset to cook a different type of meat. For specific information on the settings available, see the "Auto combination setting chart" on page 60.

1. Put food in oven and close the door.

2. Choose setting.

Touch AUTO WT. COOK, followed by a Number Pad from 1 to 7 (for food category).

TOUCH

AUTO WT.
COOK

1 225°

(example for rare beef)

YOU SEE



3. Enter food's weight (in pounds and tenths of a pound).

Enter a weight between 0.1 and 5.9 pounds.

Example for 1.5 lbs:

TOUCH

1 225°

5 325°

YOU SEE



4. Start oven.

TOUCH

START
ENTER

YOU SEE



For two out of every ten seconds:

YOU SEE



(example for Auto Combination 1)

COMBINATION COOKING

5. During cooking, five tones will sound.

Open door, stir, turn over, or rearrange food.

NOTE: If you do not do this step, the oven will continue cooking.

At end of cooking time:

YOU SEE



(for 5 seconds)

YOU SEE

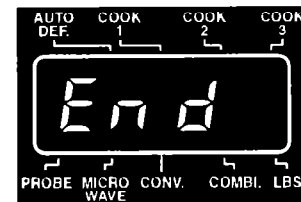

(three tones will sound)

6. After cooking, open the door.

OR TOUCH



YOU SEE



(time of day)

Auto combination setting chart

SETTING	CATEGORY	MINIMUM/MAXIMUM FOOD WEIGHT
AUTO COMBINATION 1	Rare Beef	0.1/5.9 lbs
AUTO COMBINATION 2	Medium Beef	0.1/5.9 lbs
AUTO COMBINATION 3	Well-Done Beef	0.1/5.9 lbs
AUTO COMBINATION 4	Medium Lamb	0.1/5.9 lbs
AUTO COMBINATION 5	Well-Done Lamb	0.1/5.9 lbs
AUTO COMBINATION 6	Pork	0.1/5.9 lbs
AUTO COMBINATION 7	Poultry	0.1/5.9 lbs

Caring For Your Microwave-Convection Oven

To make sure your microwave oven looks good and works well for a long time, you should maintain it properly. For proper care, please follow these instructions carefully.

Cleaning the microwave oven

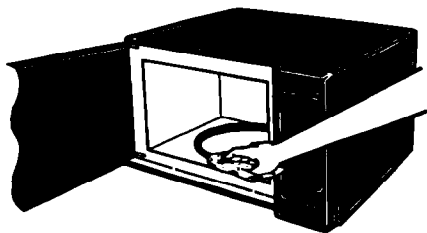

Wipe often with warm, sudsy water and a sponge or paper towel. You can remove the glass turntable to clean the oven cavity floor; however, this oven is designed to operate with the turntable in place. **Do not** operate the microwave oven when turntable is removed for cleaning. See page 7 for further information about the turntable.

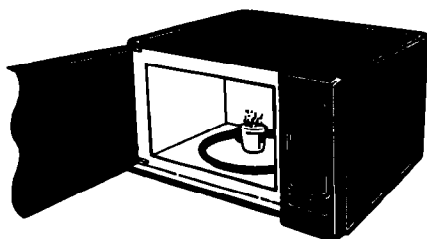

For stubborn soil, **boil** a cup of water in the oven for 2 or 3 minutes. Steam will soften the soil. To get rid of odors inside the oven, **boil** a cup of water with lemon juice.

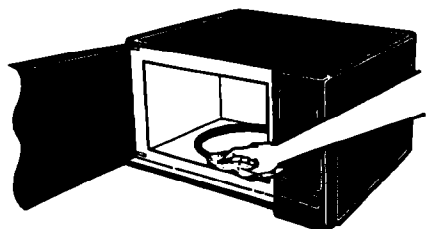

Be sure to keep the areas clean where the door and oven frame touch when closed. Use only mild, nonabrasive soaps or detergents applied with a sponge or paper towel when cleaning surfaces. Rinse well.

⚠ CAUTION

Product Damage Hazard

Abrasive cleansers, steel-wool pads, gritty wash cloths, etc., can damage the control panel, and the interior and exterior oven surfaces. Use a sponge with a mild detergent or a paper towel with spray glass cleaner. Apply spray glass cleaner to paper towel; do not spray directly on oven.

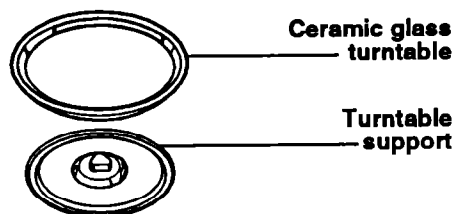

To clean turntable and turntable support, wash in mild, sudsy water; for heavily soiled areas use a mild cleanser and scouring sponge. The turntable and turntable support are dishwasher-safe.

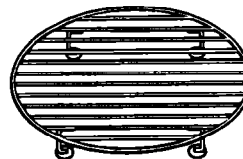

To clean the Bi-Level Cooking Rack, wash in mild, sudsy water; for heavily soiled areas use a mild cleanser and scouring sponge. Rack is dishwasher-safe. Remove from oven when not being used for cooking.

Cooking Guide

Reheating chart

Times are approximate and may need to be adjusted to individual taste.

ITEM	STARTING TEMP	TIME/POWER	PROCEDURE
Meat (Chicken pieces, chops, hamburgers, meat loaf slices) 1 serving 2 servings	Refrigerated Refrigerated	1-2 min at 70% 2½-4½ min at 70%	Cover loosely.
Meat Slices (Beef, ham, pork, turkey) 1 or more servings	Room temp Refrigerated	45 sec-1 min per serving at 50% 1-3 min per serving at 50%	Cover with gravy or wax paper. Check after 30 sec per serving.
Stirrable Casseroles and Main Dishes 1 serving 2 servings 4-6 servings	Refrigerated Refrigerated Refrigerated	2-4 min at 100% 4-6 min at 100% 6-8 min at 100%	Cover. Stir after half the time.
Nonstirrable Casseroles and Main Dishes 1 serving 2 servings 4-6 servings	Refrigerated Refrigerated Refrigerated	5-8 min at 50% 9-12 min at 50% 13-16 min at 50%	Cover with wax paper.
Soup, Cream 1 cup 1 can (10¾ oz)	Refrigerated Room temp	3-4½ min at 50% 5-7 min at 50%	Cover. Stir after half the time.
Soup, Clear 1 cup 1 can (10¾ oz)	Refrigerated Room temp	2½-3½ min at 100% 4-5½ min at 100%	Cover. Stir after half the time.
Pizza 1 slice 1 slice 2 slices 2 slices	Room temp Refrigerated Room temp Refrigerated	15-25 sec at 100% 30-40 sec at 100% 30-40 sec at 100% 45-55 sec at 100%	Place on paper towel.
Vegetables 1 serving 2 servings	Refrigerated Refrigerated	¾-1½ min at 100% 1½-2½ min at 100%	Cover. Stir after half the time.
Baked Potato 1 2	Refrigerated Refrigerated	1-2 min at 50% 2-3 min at 50%	Cut potato lengthwise and then several times crosswise. Cover with wax paper.
Breads (Dinner or breakfast roll) 1 roll 2 rolls 4 rolls	Room temp Room temp Room temp	8-12 sec at 50% 11-15 sec at 100% 18-22 sec at 100%	Wrap single roll, bagel or muffin in paper towel. To reheat several, line plate with paper towel. Cover with another paper towel.
Pie Whole 1 slice	Refrigerated Refrigerated	5-7 min at 70% 30 sec at 100%	

Microwave cooking chart

Times are approximate and may need to be adjusted to individual taste.

MEATS, POULTRY, FISH, SEAFOOD Allow standing time after cooking.			VEGETABLES (continued) Cook at 100% Cook Power.	
FOOD	COOK POWER	TIME	FOOD	TIME
Bacon	100%	45 sec to 1 min 15 sec per slice	Carrots (1 lb)	8-12 min
Ground Beef for Casseroles (1 lb)	100%	4-6 min	Cauliflower (medium head)	6-9 min
Hamburger Patties (2)	100%	1st side 2 min 2nd side 1½ to 2½ min	Corn on the Cob (2)	4-9 min
Hamburger Patties (4)	100%	1st side 2½ min 2nd side 2-3 min	Corn on the Cob (4)	6-16 min
Meat Loaf (1½ lbs)	100%	13-19 min	Potatoes, Baked (4 medium)	13-19 min
Chicken Pieces	100%	6-9 min/lb Internal temperature should be 185°F after standing.	Squash, Summer (1 lb)	3-8 min
Turkey Breast	100% then 70%	5 min 8-12 min/lb Internal temperature should be 185°F after standing.	OTHER	
Fish Fillets (1 lb)	100%	5-6 min	FOOD	COOK POWER
Scallops and Shrimp (1 lb)	100%	3½-5½ min	TIME	
VEGETABLES Cook at 100% Cook Power.			Applesauce (4 servings)	100% 7-10 min
FOOD		TIME	Baked Apples (4)	100% 4-6 min
Beans, Green or Yellow (1 lb)		6-12 min	Chocolate (melt 1 square)	50% 1-2 min
Broccoli (1 lb)		6-10 min	Eggs, Scrambled (2)	100% 1 min 15 sec to 1 min 45 sec
			Eggs, Scrambled (4)	2-3 min
			Hot Cereals (1 serving)	100% 1½-5 min
			Hot Cereals (4 servings)	4½-7 min
			Nachos (large plate)	50% 1½-2½ min
			Water for Beverage (1 cup)	100% 2½-4 min
			Water for Beverage (2 cups)	4½-6 min

Microwave cooking tips

Amount of food

- **The more food** you want to prepare, the longer it takes. A rule of thumb is that a double amount of food requires almost double the time. If one potato takes four minutes to cook, you need about seven minutes to cook two potatoes.
- **If you want to cook two meals or containers of food** at the same time, you can do so with the Bi-Level Cooking Rack. For example, you can cook two frozen dinners or reheat two plates of food by placing one on the rack and one under the rack.

Starting temperature of food

- **The lower the temperature** of the food being put into the microwave oven, the longer it takes to cook. Food at room temperature will be reheated more quickly than food at refrigerator temperature.

Composition of food

- **Food with a lot of fat and sugar** will be heated faster than food containing a lot of water. Fat and sugar will also reach a higher temperature than water in the cooking process.
- **The more dense the food**, the longer it takes to heat. "Very dense" food like meat takes longer to reheat than lighter, more porous food like sponge cakes.

Size and shape

- **Smaller pieces of food** will cook faster than larger pieces and same-shaped pieces of food cook more evenly than irregularly shaped foods.
- **With unevenly shaped foods**, the thinner parts will cook faster than the thicker areas. **Place** the thinner parts of chicken wings and legs in the center of the dish.

Stirring, turning foods

- **Stirring and turning foods** distributes heat quickly to the center of the dish and avoids overcooking at the outer edges of the food.

Covering food

Cover food to:

- **Reduce** splattering
- **Shorten** cooking times
- **Retain** food moisture

All coverings that allow microwaves to pass through are suitable.

Releasing pressure in foods

- **Several foods** (for example: baked potatoes, sausages, egg yolks, and some fruits) are tightly covered by a skin or membrane. This can cause the food to burst from steam building up in them during cooking. To relieve the pressure and to prevent bursting, **prick** these foods with a fork, cocktail pick or toothpick.

Using standing time

- **Always allow food to stand** for a while after cooking. Standing time after defrosting, cooking, or reheating always improves the result since the temperature will then be evenly distributed throughout the food.
- **When cooking in a microwave oven**, food continues to cook even when the microwave energy is turned off. Food is no longer cooked by microwaves, but it is still being cooked by the high heat left over from the microwave oven.
- **The length of the standing time** depends on the volume and density of the food. Sometimes it can be as short as the time it takes you to remove the food from the oven and take it to the serving table. However, with larger, denser food, the standing time may be as long as 10 minutes. During standing time, the internal food temperature will rise as much as 46°F as the food finishes cooking.

Arranging food

For best results, distribute food evenly on the plate. You can do this in several ways:

- **If you are cooking several items of the same food**, such as baked potatoes, **place** them in a ring pattern for uniform cooking.
- **When cooking foods of uneven shapes or thickness**, **place** the smaller or thinner area of the food towards the center of the dish where it will be heated last.
- **Arrange uneven foods**, such as fish, in the oven with the tails to the center.
- **If you are saving a meal in the refrigerator** or “plating” a meal for reheating, **arrange** the thicker, denser foods to the outside of the plate and the thinner or less dense foods in the middle.
- **Place thin slices of meat** on top of each other or interlace them.
- **Place thicker slices of meat**, such as meat loaf and sausages, close to each other.
- **Reheat gravy or sauce** in a separate container.
- **When you cook or reheat whole fish**, **score** the skin – this prevents cracking.
- **Shield the tail and head of whole fish** with small pieces of foil to prevent overcooking and ensure the foil does not touch the sides of the oven.
- **Do not** let food or container touch the top or sides of the oven. This will prevent possible arcing.

Using aluminum foil

Metal containers usually should not be used in a microwave oven. There are, however, some exceptions. If you have purchased food which is prepackaged in an aluminum foil container, then refer to the instructions on the package. It is possible to use disposable containers, but it generally takes longer and the final result will not be as good as if food were placed in plastic or paper containers.

If you use aluminum containers without package instructions, follow these guidelines:

- **Place** container in a glass bowl and add some water so that it covers the bottom of the container, not more than ¼ inch high. This ensures even heating of the container bottom.
- **Always remove** the lid to avoid damage to the oven.
- **Use only** undamaged containers.
- **Do not use** containers taller than ¾”.
- **Container must be** half filled.
- **To avoid sparking**, there must be a minimum ¼” between the aluminum container and the walls of the oven and also between two aluminum containers.
- **Always place** container on turntable.
- **Thickness of the food layer** must be greater than thickness of the aluminum.
- **Reheating food** in aluminum foil containers usually takes up to double the time compared to reheating in plastic, glass, china, or paper containers. The time when food is ready will vary a great deal.
- **Let food stand** for 2-3 minutes after heating so that heat is spread evenly throughout container.

Cooking you should not do in your microwave oven

- **Do not** do canning of foods in the oven. Closed glass jars may explode, resulting in damage to the oven or possible personal injury.
- **Do not** use the oven to sterilize objects (baby bottles, etc.). It is difficult to maintain the high temperature required for safe sterilization.

COOKING GUIDE

Oven utensils guide

You can use a variety of utensils and materials in your microwave-convection oven. For your safety and to prevent damage to utensils and your oven, choose appropriate utensils and materials for each cooking method. The list below is a general guide to help you select the correct utensils and materials.

MATERIAL	UTENSILS	MICROWAVE COOKING	COMBINATION COOKING	CONVECTION COOKING
Ceramic & Glass	Ceramic	YES	YES	YES
	Ovenproof, Heat-Tempered, Microwave-Safe Glassware	YES	YES	YES
	Glassware with Metal Decoration	NO	NO	YES
	Lead Glass	NO	NO	YES
China	Without Metal Decoration (Ovenproof and Heat-Tempered)	YES	YES	YES
Pottery		YES	YES	YES
Plastic	Regular Ovenproof	YES	YES	YES
	Heat-Tempered Ware	YES	NO	NO
Metal	Bake/Roast Rack	NO	NO	YES
	Metal Baking Pan	NO	NO	YES
	Aluminum Foil	*	*	YES
Paper	Cups, Plates, Towels	YES	NO	NO
Straw, Wicker, Wood		YES	NO	NO
Wax Paper		YES	NO	NO
Plastic Wrap		YES	NO	NO

YES: Utensils to use

NO: Utensils to avoid

*Refer to "Microwave cooking tips" on page 65 and "Questions And Answers" on page 67 for proper use.

Questions And Answers

QUESTIONS	ANSWERS
Can I operate my microwave oven without the turntable or turn the turntable over to accommodate a large dish?	No. If you remove or turn over the turntable, you will get poor cooking results. Dishes used in your oven must fit on the turntable.
Can I use a rack in my microwave oven so that I may reheat or cook on two levels at a time?	You can use a rack only if rack is supplied with your microwave oven. Use of any rack not supplied with the microwave oven can result in poor cooking performance and/or arcing.
Can I use either metal or aluminum pans in my microwave oven?	Useable metal includes aluminum foil for shielding (use small, flat pieces), small skewers and shallow foil trays (if tray is 3/4 inch deep and filled with food to absorb microwave energy). Never allow metal to touch walls or door. (For more information, see page 65.)
Is it normal for the turntable to turn in either direction?	Yes. The turntable rotates clockwise or counterclockwise, depending on the rotation of the motor when the cooking cycle begins.
Sometimes the door of my microwave oven appears wavy. Is this normal?	This appearance is normal and does not affect the operation of your oven.
What are the humming noises that I hear when my microwave oven is operating?	You hear the sound of the transformer when the magnetron tube cycles on.
Why does the dish become hot when I microwave food in it? I thought that this should not happen.	As the food becomes hot it will conduct the heat to the dish. Be prepared to use hot pads to remove food after cooking.
What does "standing time" mean?	"Standing time" means that food should be taken out of the oven and covered for additional time after cooking. This process allows the cooking to finish, saves energy and frees the oven for another purpose.
Can I pop popcorn in my microwave oven? How do I get the best results?	Yes. Pop packaged microwave popcorn following manufacturer's guidelines or use the preprogrammed Popcorn pad. Do not use regular paper bags. Use the "listening test" by stopping the oven as soon as the popping slows to a "pop" every one or two seconds. Do not try to repop unpopped kernels. You can also use special microwave poppers. When using a popper, be sure to follow manufacturer's directions. Do not pop popcorn in glass utensils.
Why does steam come out of the air exhaust vent?	Steam is normally produced during cooking. The microwave oven has been designed to vent this steam out the top vent.

IF YOU NEED ASSISTANCE OR SERVICE

If You Need Assistance Or Service

This section is designed to help you save the cost of a service call. Part 1 of this section outlines possible problems, their causes, and actions you can take to solve each problem. Parts 2 and 3 tell you what to do if you still need assistance or service. When calling our Consumer Assistance Center for help or calling for service, please provide a detailed description of the problem, your appliance's complete model and serial numbers and the purchase date. (See page 2.) This information will help us respond properly to your request.

1. Before calling for assistance ...

Performance problems often result from little things you can find and fix without tools of any kind. Please check the chart below for problems you can fix. It could save you the cost of a service call.

PROBLEM	POSSIBLE CAUSE	SOLUTION
Nothing will operate	<p>The power supply cord is not plugged into a live circuit with the proper voltage.</p> <p>A household fuse has blown or a circuit breaker has tripped.</p> <p>The electric company has experienced a power failure.</p>	<p>Plug power supply cord into a live circuit with the proper voltage. (See pages 7 and 9.)</p> <p>Replace household fuse or reset circuit breaker.</p> <p>Check electric company for a power failure.</p>
The microwave oven will not run	<p>If Temperature Probe is being used, it is not plugged tightly into its socket.</p> <p>The door is not firmly closed and latched.</p> <p>You did not touch START/ENTER.</p> <p>You did not follow directions exactly.</p> <p>An operation that was programmed earlier is still running.</p>	<p>Plug in Temperature Probe securely.</p> <p>Firmly close and latch door.</p> <p>Touch START/ENTER.</p> <p>Check instructions for the function you are operating.</p> <p>Touch OFF/CANCEL to cancel previous programming.</p>
Microwave cooking times seem too long	<p>The electric supply to your home or wall outlets is low or lower than normal.</p> <p>The Cook Power is not at the recommended setting.</p> <p>There is not enough cooking time for the amount of food being cooked.</p>	<p>Your electric company can tell you if the line voltage is low. Your electrician or service technician can tell you if the outlet voltage is low.</p> <p>Check "Microwave cooking chart" on page 63.</p> <p>Allow for more time when cooking more food at one time.</p>

IF YOU NEED ASSISTANCE OR SERVICE

PROBLEM	POSSIBLE CAUSE	SOLUTION
The Display shows a time counting down but the oven is not cooking	<p>The oven door is not closed completely.</p> <p>You have set the controls as a minute timer.</p>	<p>Completely close oven door.</p> <p>Touch OFF/CANCEL to cancel the Minute Timer.</p>
You do not hear the Programming Tone	<p>The command is not correct.</p>	<p>Re-enter command.</p>
The fan seems to be running slower than usual	<p>The oven has been stored in a cold area.</p>	<p>The fan will run slower until the oven warms up to normal room temperature.</p>
Foods undercook during convection and combination cooking	<p>You have not followed the recipe closely enough.</p> <p>Foods are not prepared and ready to place in the oven. This increases heat loss from the door being open.</p>	<p>Follow reliable recipes exactly for ingredients, utensils, cooking time and proper rack position.</p> <p>Make sure foods are properly prepared and ready to place in oven.</p>
Smoke is coming from back of oven during broiling	<p>This is normal, just as in conventional broiling.</p>	
The microwave oven turns off too soon or not soon enough when using the Temperature Probe	<p>Probe is not pushed far enough into the food.</p> <p>Probe is not positioned correctly in the food.</p> <p>When cooking roasts, you have not let roast stand after cooking.</p> <p>Probe is not plugged in correctly.</p> <p>Cook Power is not set correctly.</p> <p>Probe temperature is not set correctly.</p>	<p>Insert at least 1/3 of probe into the food.</p> <p>Position probe tip in the center of the food.</p> <p>Allow roast to stand for a few minutes after cooking.</p> <p>Plug probe tightly into its socket.</p> <p>Reset the Cook Power.</p> <p>Reset the probe temperature.</p>
The Display shows ": 0"	<p>There has been a power interruption.</p>	<p>Reset the clock.</p>

IF YOU NEED ASSISTANCE OR SERVICE

2. If you need assistance ...

Call Whirlpool Consumer Assistance Center telephone number. Dial toll-free from anywhere in the U.S.A.:

1-800-253-1301

and talk with one of our trained consultants. The consultant can instruct you in how to obtain satisfactory operation from your appliance or, if service is necessary, recommend a qualified service company in your area.

If you prefer, write to:

Mr. William Clark
Consumer Assistance Representative
Whirlpool Corporation
2000 M-63
Benton Harbor, MI 49022

Please include a daytime phone number in your correspondence.

3. If you need service ...



Whirlpool has a nationwide network of authorized Whirlpool® service companies. Whirlpool service technicians are trained to fulfill the product warranty and provide after-warranty service, anywhere in the United States. To locate the authorized Whirlpool service company in your area, call our Consumer Assistance Center telephone number (see Step 2) or look in your telephone directory Yellow Pages under:

**• APPLIANCE-HOUSEHOLD-
MAJOR, SERVICE & REPAIR**

- See: Whirlpool Appliances or
Authorized Whirlpool Service
(Example: XYZ Service Co.)

**• WASHING MACHINES &
DRYERS, SERVICE & REPAIR**

- See: Whirlpool Appliances or
Authorized Whirlpool Service
(Example: XYZ Service Co.)

4. If you are not satisfied with how the problem was solved ...

- Contact the Major Appliance Consumer Action Panel (MACAP). MACAP is a group of independent consumer experts that voices consumer views at the highest levels of the major appliance industry.
- Contact MACAP only when the dealer, authorized servicer and Whirlpool have failed to resolve your problem.

Major Appliance Consumer Action Panel
20 North Wacker Drive
Chicago, IL 60606

- MACAP will in turn inform us of your action.

WHIRLPOOL®

Microwave Oven Warranty

LENGTH OF WARRANTY	WHIRLPOOL WILL PAY FOR
FULL ONE-YEAR WARRANTY From Date of Purchase	FSP® replacement parts and repair labor to correct defects in materials or workmanship. Service must be provided by an authorized Whirlpool® service company.
LIMITED FOUR-YEAR WARRANTY Second Through Fifth Year From Date of Purchase	FSP replacement magnetron tube on microwave ovens if defective in materials or workmanship.
WHIRLPOOL WILL NOT PAY FOR	
<p>A. Service calls to:</p> <ol style="list-style-type: none"> 1. Correct the installation of your microwave oven. 2. Instruct you how to use your microwave oven. 3. Replace house fuses or correct house wiring. 4. Replace owner accessible light bulbs. <p>B. Repairs when your microwave oven is used in other than normal, single-family household use.</p> <p>C. Pickup and delivery. Your microwave oven is designed to be repaired in the home.</p> <p>D. Damage to your microwave oven caused by accident, misuse, fire, flood, acts of God or use of products not approved by Whirlpool.</p> <p>E. Any labor costs during limited warranty.</p> <p>F. Repairs to parts or systems caused by unauthorized modifications made to the appliance.</p>	

5/93

WHIRLPOOL CORPORATION SHALL NOT BE LIABLE FOR INCIDENTAL OR CONSEQUENTIAL DAMAGES. Some states do not allow the exclusion or limitation of incidental or consequential damages, so this limitation or exclusion may not apply to you. This warranty gives you specific legal rights, and you may also have other rights which vary from state to state.

Outside the United States, a different warranty may apply. For details, please contact your authorized Whirlpool distributor or military exchange.

If you need service, first see the "Assistance or Service" section of this book. After checking "Assistance or Service," additional help can be found by calling our Consumer Assistance Center telephone number, 1-800-253-1301, from anywhere in the U.S.A.

PART NO. 3874WR00264/4358412 Rev. A

© 1993 Whirlpool Corporation

® Registered Trademark of Whirlpool Corporation.

Printed in Korea